

Earth continuity Tester **TOS6200**

Operation Manual

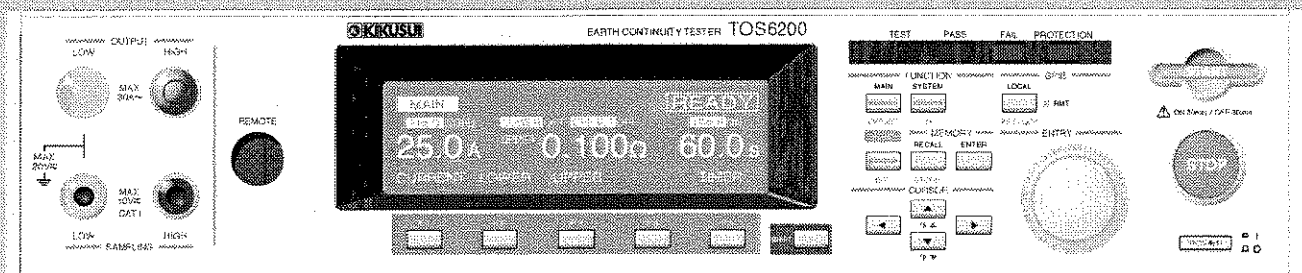

Part No. Z1-002-252, IB002615

Use of Operation Manual

Please read through and understand this Operation Manual before operating the product. After reading, always keep the manual nearby so that you may refer to it as needed. When moving the product to another location, be sure to bring the manual as well.

If you find any incorrectly arranged or missing pages in this manual, they will be replaced. If the manual it gets lost or soiled, a new copy can be provided for a fee. In either case, please contact Kikusui distributor/agent, and provide the "Part No." given on the cover.

This manual has been prepared with the utmost care; however, if you have any questions, or note any errors or omissions, please contact Kikusui distributor/agent.

Microsoft, Windows95, Windows98, WindowsNT, Windows2000 and Visual Basic are registered trademarks of Microsoft Corp., U.S.A.

National Instruments and NI-488.2 are registered trademarks of National Instruments Corp., U.S.A.

Trade names, product names, and company names occurring in this manual are trademarks or registered trademarks of their respective holders.

The contents of this Operation Manual may not be reproduced, in whole or in part, without the prior consent of the copyright holder.

The specifications of this product and the contents of this Operation Manual are subject to change without prior notice.

Power Requirements of this Product

Power requirements of this product have been changed and the relevant sections of the Operation Manual should be revised accordingly. (Revision should be applied to items indicated by a check mark)

Input voltage

The input voltage of this product is 120 VAC,
and the voltage range is 85 to 132 VAC.

Use the product within this range only.

Input fuse

The rating of this product's input fuse is 6.3 A, 250 VAC, and S,B.

- ⚠ WARNING**
- To avoid electrical shock, always disconnect the AC power cord before attempting to check or replace the fuse.
 - Use a fuse element having a shape, rating, and characteristics suitable for this product. The use of a fuse with a different rating or one that short circuits the fuse holder may result in fire, electric shock, or irreparable damage.

AC power cord

The product is provided with AC power cords described below. If the cord has no power plug, attach a power plug to the cord in accordance with the wire colors specified in the drawing.

- ⚠ WARNING**
- The attachment of a power plug must be carried out by qualified personnel.

Without a power plug

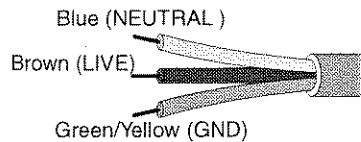

Without a power plug

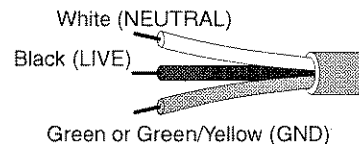

Plugs for USA

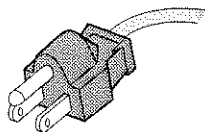

Plugs for Europe

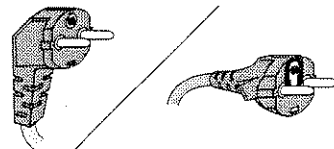

Provided by Kikusui distributor/agent

Kikusui agents can provide you with suitable AC power cord.
For further information, contact Kikusui distributor/agent.

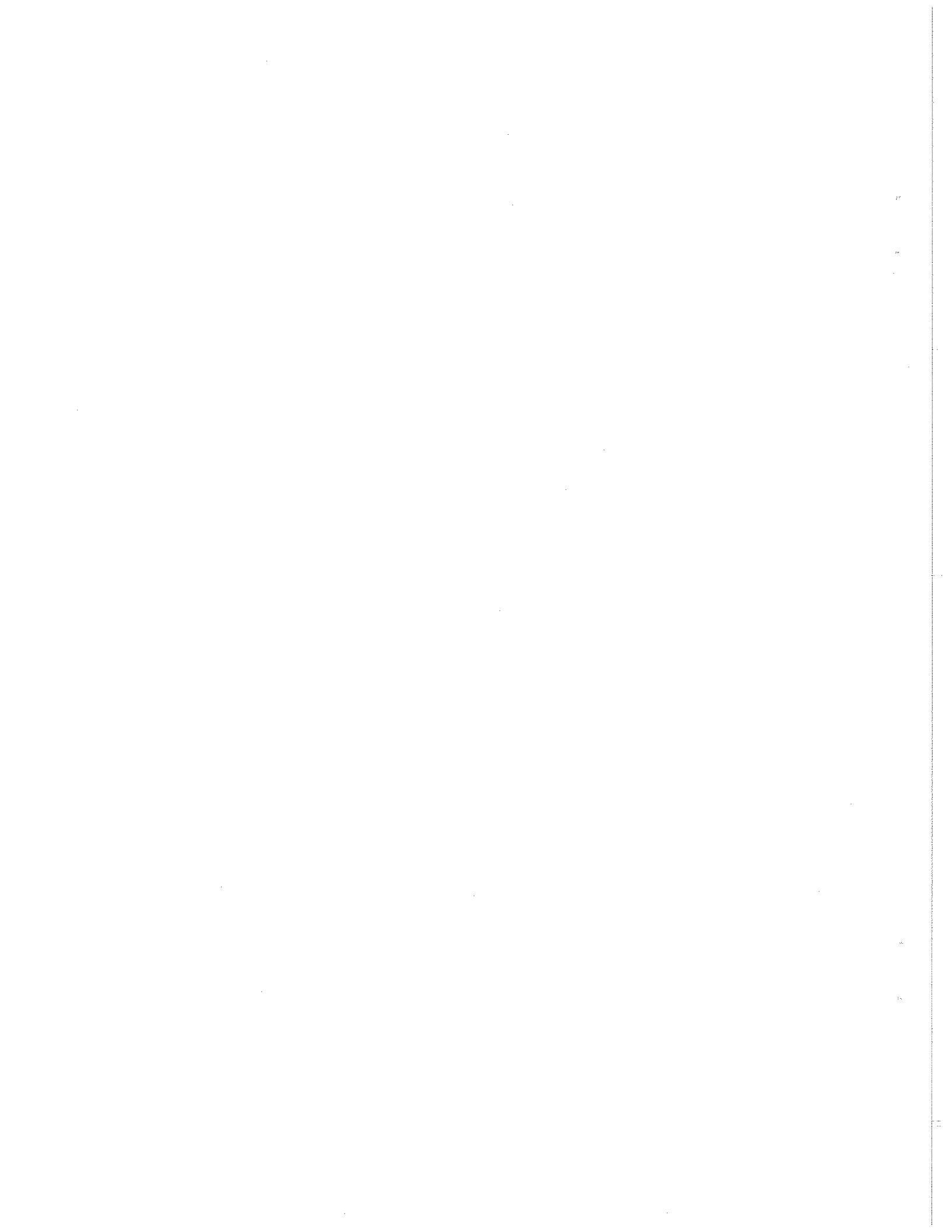

Safety Symbols

For the safe use and safe maintenance of this product, the following symbols are used throughout this manual and on the product. Understand the meanings of the symbols and observe the instructions they indicate (the choice of symbols used depends on the products).

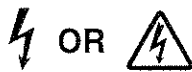

Indicates that a high voltage (over 1,000 V) is used here. Touching the part causes a possibly fatal electric shock. If physical contact is required by your work, start work only after you make sure that no voltage is output here.

DANGER

Indicates an imminently hazardous situation which, if ignored, will result in death or serious injury.



Indicates a potentially hazardous situation which, if ignored, could result in death or serious injury.



Indicates a potentially hazardous situation which, if ignored, may result in damage to the product and other property.



Shows that the act indicated is prohibited.



Is placed before the sign "DANGER," "WARNING," or "CAUTION" to emphasize these. When this symbol is marked on the product, see the relevant sections in this manual.



Indicates an earth ground terminal.



Indicates a chassis ground terminal.

Safety Precautions

The following safety precautions must be observed to avoid fire hazard, electrical shock, accidents, and other failures. Keep them in mind and make sure that all of them are observed properly.



Users

- This product must be used only by qualified personnel who understand the contents of this operation manual.
- If it is handled by disqualified personnel, personal injury may result. Be sure to handle it under supervision of qualified personnel (those who have electrical knowledge.)

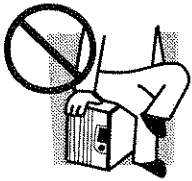

Purposes of use

- Do not use the product for purposes other than those described in the operation manual.

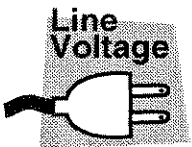

Input power

- Use the product with the specified input power voltage.
- For applying power, use the AC power cord provided. Note that the provided power cord is not use with some products that can switch among different input power voltages or use 100 V and 200 V without switching between them. In such a case, use an appropriate power cord. For details, see the relevant page of this operation manual.

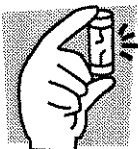

Fuse

- With products with a fuse holder on the exterior surface, the fuse can be replaced with a new one. When replacing a fuse, use the one which has appropriate shape, ratings, and specifications.

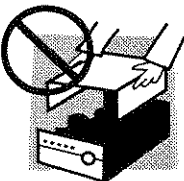

Cover

- There are parts inside the product which may cause physical hazards. Do not remove the external cover.

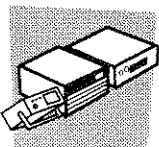

Installation

- When installing products be sure to observe "Precautions for Installation" described in this manual.
- To avoid electrical shock, connect the protective ground terminal to electrical ground (safety ground).
- When installing products with casters, be sure to lock the casters.

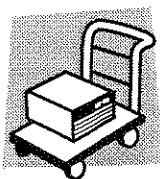

Relocation

- Turn off the power switch and then disconnect all cables when relocating the product.
- Use two or more persons when relocating the product which weights more than 20 kg. The weight of the products can be found on the rear panel of the product and/or in this operation manual.
- Use extra precautions such as using more people when relocating into or out of present locations including inclines or steps. Also handle carefully when relocating tall products as they can fall over easily.
- Be sure the operation manual be included when the product is relocated.



Operation

- Check that the AC input voltage setting and the fuse rating are satisfied and that there is no abnormality on the surface of the AC power cord. Be sure to unplug the AC power cord or stop applying power before checking.
- If any abnormality or failure is detected in the products, stop using it immediately. Unplug the AC power cord or disconnect the AC power cord from the switchboard. Be careful not to allow the product to be used before it is completely repaired.
- For output wiring or load cables, use connection cables with larger current capacity.
- Do not disassemble or modify the product. If it must be modified, contact Kikusui distributor/agent.



Maintenance and checking

- To avoid electrical shock, be absolutely sure to unplug the AC power cord or stop applying power before performing maintenance or checking.
- Do not remove the cover when performing maintenance or checking.
- To maintain performance and safe operation of the product, it is recommended that periodic maintenance, checking, cleaning, and calibration be performed.



Service

- Internal service is to be done by Kikusui service engineers. If the product must be adjusted or repaired, contact Kikusui distributor/agent.

Overvoltage category

To standardize insulation requirements with respect to the level of transient overvoltage, IEC60664 (Insulation coordination for equipment within low-voltage systems) classifies circuits into four categories according to the frequency of occurrence of voltage transients. For details, see the IEC Standards.

Overvoltage category I

Equipment of overvoltage category I is equipment for connection to circuits in which measures are taken to limit transient overvoltages to an appropriately low level.

Examples are protected electronic circuits.

Overvoltage category II

Equipment of overvoltage category II is energy-consuming equipment to be supplied from the fixed installation.

Examples of such equipment are appliances, portable tools and other household and similar loads.

If such equipment is subjected to special requirements with regard to reliability and availability, overvoltage category III applies.

Overvoltage category III

Equipment of overvoltage category III is equipment in fixed installations and for cases where the reliability and the availability of the equipment is subject to special requirements.

Examples of such equipment are switches in the fixed installation and equipment for industrial use with permanent connection to the fixed installation.

Overvoltage category IV

Equipment of overvoltage IV is for use at the origin of the installation.

Example of such equipment are electricity meters and primary overcurrent protection equipment.

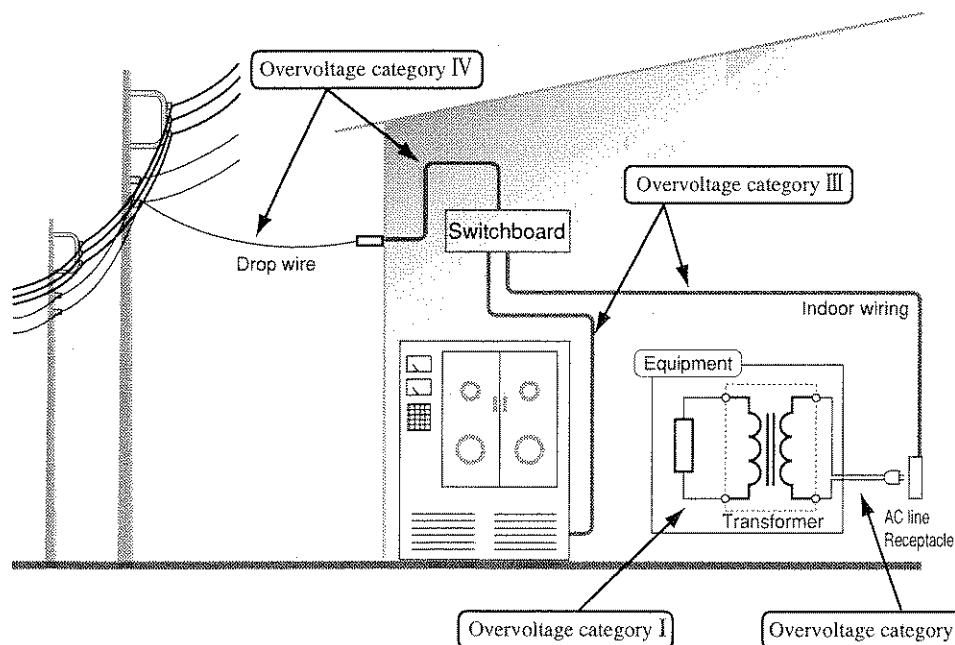

Sections of the operation manual

The contents of this operation manual are as follows:

Preface

Gives an overview of the tester and describes its features and various options.

Chapter 1 Setup

Describes proper procedures for performing specific tasks, from unpacking to installation to preparation required before switching on POWER.

Precautions for installing and connecting the AC power cord are provided here. Read this chapter before using the tester.

Chapter 2 Basic Operation

Describes basic operations such as setting test conditions and starting a test.

Chapter 3 REMOTE and SIGNAL I/O

Describes the REMOTE terminal (for connecting optional equipment) and the SIGNAL I/O connector (for input/output signals).

Chapter 4 GPIB and RS-232C

Gives the device messages used to control the tester via a GPIB or RS-232C interface.

Chapter 5 Part Names and Functions

Gives the names and functions of switches, connectors, and other parts on the front and rear panels.

This chapter provides descriptions of the \triangle (alert) symbols located on tester panels.

Chapter 6 Maintenance

Explains tester maintenance, inspection, and calibration.



Chapter 7 Specifications

Provides tester specifications.

Appendix

Explains basic tester principles; provides a table for ASCII codes 20H to 7EH and excerpts from various earth continuity test safety standards.

Contents

 Safety Symbols	I
 Safety Precautions	II
Preface	P-1
Overview of the Manual	P-1
Introduction and Features	P-2
Options	P-5
Chapter 1 Setup	1-1
1.1 Unpacking Checks	1-1
1.2 Precautions for installation	1-3
1.3 Precautions for moving	1-4
1.4 For Long and Trouble-free Service Life	1-4
1.5 Checking the Line Voltage	1-5
1.6 Connecting the AC Power Cord	1-5
1.7 Grounding	1-6
1.8 Connecting the Test Leads	1-7
1.8.1 Supplied Test Lead TL11-TOS	1-7
1.8.2 Optional Test Probe	1-9
1.8.3 Other Leads	1-10
1.8.4 Measurements Using Four Terminals	1-10
1.8.5 Measurements Using Two Terminals	1-11
1.8.6 Connecting to the DUT	1-12
1.9 Preliminary Inspection	1-13
Chapter 2 Basic Operation	2-1
2.1 Turning on the power	2-1
2.2 Setting the Test Conditions	2-2
2.2.1 Setting Test Current	2-4
2.2.2 Setting Test Frequency	2-5
2.2.3 ON/OFF of Lower Limit Judgment	2-6
2.2.4 Setting the Lower Reference Value	2-6
2.2.5 Setting the Upper Reference Value	2-7
2.2.6 Timer ON/OFF Settings	2-8
2.2.7 Setting the Test Time	2-9
2.2.8 Offset Canceling Function ON/OFF Settings	2-9
2.3 Starting and Ending Test	2-10
2.3.1 Starting a Test	2-10
2.3.2 Ending the Test	2-11
2.4 Offset Canceling Function	2-13

2.5	System Setup	2-14
2.6	Interface Setup	2-18
2.7	Panel Memory	2-20
2.7.1	Storing in the Panel Memory	2-20
2.7.2	Recalling the Panel Memory	2-21
2.8	Program	2-22
2.8.1	Recalling the Program	2-23
2.8.2	Creating or Editing the Program	2-23
2.8.3	Running the Program	2-25
2.8.4	Suspending the Program	2-25
2.8.5	Program PASS/FAIL Judgment	2-25
2.8.6	Exiting the Program	2-26
2.9	Key Lock	2-26
2.10	Protection	2-27
2.11	Initialize	2-30

Chapter 3 REMOTE and SIGNAL I/O **3-1**

3.1	REMOTE Terminal	3-1
3.2	SIGNAL I/O Connector	3-2
3.2.1	SIGNAL I/O Connector Specifications	3-2
3.2.2	Starting a Test	3-5
3.2.3	Recalling a Panel Memory and Program	3-6
3.2.4	Examples of Use	3-7

Chapter 4 GPIB and RS-232C **4-1**

4.1	Interface	4-1
4.1.1	GPIB Interface	4-1
4.1.2	RS-232C Interface	4-1
4.2	Message and Terminator	4-3
4.2.1	Messages	4-3
4.2.2	Terminator	4-5
4.3	Device Messages	4-6
4.3.1	Register-Related and General-Purpose Messages	4-6
4.3.2	System-Related Messages	4-15
4.3.3	Messages Relating to Test Conditions and Test Execution	4-22
4.3.4	Messages Relating to the Tester Status	4-29
4.3.5	Memory-Related Messages	4-33
4.3.6	Program-Related Messages	4-35
4.4	Registers	4-40
4.5	List of Device Messages	4-44
4.6	Example Programs	4-48

Chapter 5	Part Names and Functions	5-1
5.1	Front Panel	5-1
5.2	Rear Panel	5-6
Chapter 6	Maintenance	6-1
6.1	Cleaning	6-1
6.2	Inspection	6-1
6.3	Checking and Replacing the Fuse	6-2
6.4	Replacing the Cooling Fan and Backup Battery	6-3
6.5	Calibration	6-3
6.6	In Case of Problems	6-4
Chapter 7	Specifications	7-1
	Basic performance	7-1
	Interface and Other Functions	7-3
	General specifications	7-5
	GPIB interface	7-7
	External dimensions	7-7
Appendix		A-1
	1. Operational Principle	A-1
	2. ASCII Codes 20H to 7EH	A-2
	3. Summary of the Safety Standards for Earth Continuity Testing	A-3
	4. Initial Settings of the Memory	A-8
INDEX		I-1

Preface

Overview of the Manual

This operation manual is for the TOS6200 earth continuity tester.

■ **This manual describes a specific product ROM version.**

Ver. 1.0X

The ROM version number is displayed in the opening screen displayed immediately after power is switched ON. You can also obtain the ROM version number with the *IDN? message. For information on the *IDN? message, see chapter 4, GPIB and RS-232C.

Before making product inquiries, please have ready the tester ROM version number and serial number indicated on the rear panel of your tester.

Opening screen for ROM version 1.01

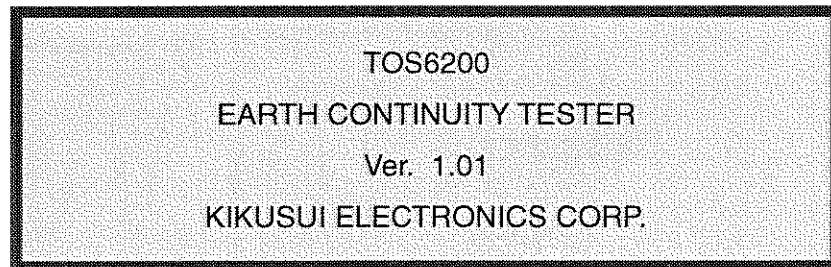

Introduction and Features

This tester is used to perform earth continuity tests required for class-I devices for various safety standards, including the IEC, EN, VDE, BS, JIS, UL, and the Electrical Appliance and Material Control Law of Japan.

The tester must be used under the following conditions:

- Test current value: 3A to 30 A AC
- Output terminal voltage: 5.4 V or less
- Resistance value: 1.2 Ω or less
- Maximum power: 150 VA or less

1. Making test current constant

The test current for earth continuity tests has been made constant. This relieves the operator of the burdensome procedure of resetting the test current when the resistance of the DUT (Device Under Test) changes.

2. Safety output voltage

The constant current/constant voltage circuit provides fast response, preventing generation of excessive output voltage even when output is interrupted during testing. The tester complies with the limitations on no-load output voltages (6 V or less, 12 V or less, and so on) required by many safety standards.

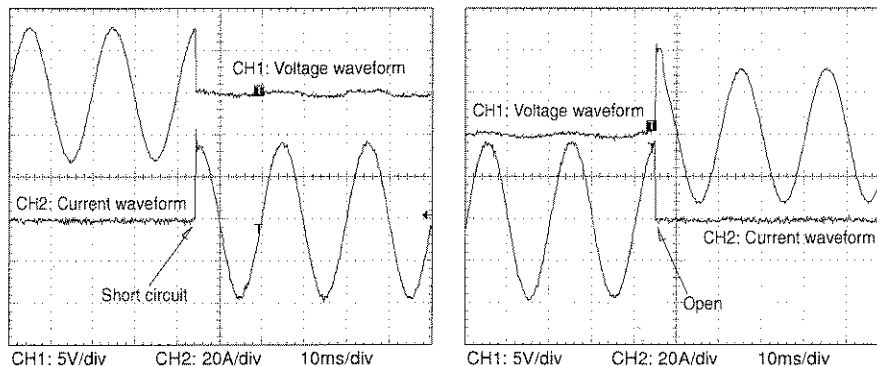

3. Reduced cycle time

A test current is a constant current value set within approximately 100 ms.

Earth continuity tests can be conducted even at 1-second intervals. This enables the instrument to perform tests in production lines that require reduced cycle times.

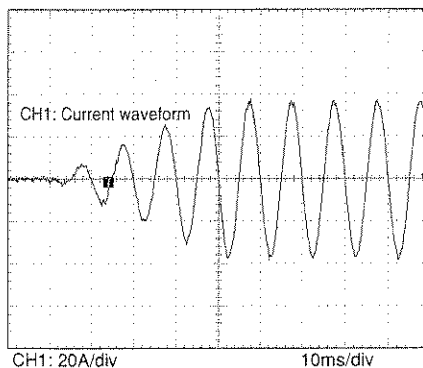

4. Compact and lightweight

A new high-efficiency power supply (achieving a power conversion efficiency of 65%) and large output (150 VA) makes possible a tester that is remarkably compact and lightweight, about half the size and weight of our conventional testers.

5. Excellent measurement accuracy

The tester is equipped with an ammeter of $\pm(1\% \text{ of reading} + 0.2 \text{ A})$, a voltmeter of $\pm(1\% \text{ of reading} + 0.02\text{V})$, and an ohmmeter of $\pm(2\% \text{ of reading} + 0.003 \text{ } \Omega)$ that calculates resistance values based on measured current and voltage.

6. Offset canceling function

The tester has an offset canceling function that cancels values for contact resistance at alligator-clip connections or other connecting points, resistance components, and the contact resistance of measuring leads in measurements using two terminals.

7. Contact check function

The tester is provided with a contact check function that verifies the connection of the DUT (by current detection) before initiating testing.

8. Simple operations

Tester functions are fast and easily controlled, with an intuitive control method that's easy to pick up, even for first-time users.

For example, test conditions are set simply by selecting an item displayed on the LCD with the cursor keys and turning the rotary knob to set/select a value.

Function keys allow you to set shortcuts to a desired setting item.

9. Stores up to 100 types of test conditions

The tester allows you to store and name up to 100 test conditions involving parameters such as test current, determined resistance value, and test time. For example, you can store test conditions for a specific safety standard under the name of the standard, or store test conditions under the name of the destination of the DUT.

When test conditions need to be modified due to changes in the destination of the product or revised safety standards, you can recall a set of test conditions simply by entering a memory number, making necessary modifications to the pre-existing standard.

Assigning specific names allows test conditions to be called up by name. This function is available through both the front panel and the remote control.

10. Programming of test conditions

A combination of stored test conditions allows automatic execution of tests consisting of several programs of up to 100 steps each.

Although the total number of steps is limited to 500, 100 types of programs can be stored and recalled from the front panel or the remote control.

11. GPIB and RS-232C interfaces

The tester is provided with standard GPIB and RS-232C interfaces. It is therefore not necessary to buy additional GPIB and RS-232C cards.

An interface cable and PC or sequencer allows remote control of test conditions such as test current, determined resistance value, and testing time. Measured values and test results can also be read back.

12. Supplied test leads

The tester comes with alligator-clip test leads, letting you start testing immediately.

13. Memo function

The tester has a memo function that can store up to 20 characters per line on 3 lines, which can be used to store serial numbers, calibration dates, and/or comments.

Options

The following options are available for the tester.

■ RC01-TOS/RC02-TOS Remote Control Box

When connected to the REMOTE terminal on the front panel, remote control boxes are used to control tester start/stop functions.

The RC01-TOS has one START switch, while the RC02-TOS has two START switches. For the RC02-TOS, a test starts only when both switches are pressed simultaneously.

Functions

OPERATE switch

Test switches are enabled only when this switch is set to the ON position.

When it is set to the OFF position, a test in progress will be stopped.

START switch

With the OPERATE switch set to ON and the tester in ready status, press this switch to start testing.

STOP switch

Used to shut off output voltage or cancel a FAIL status; has the same function as the STOP switch located on the tester.

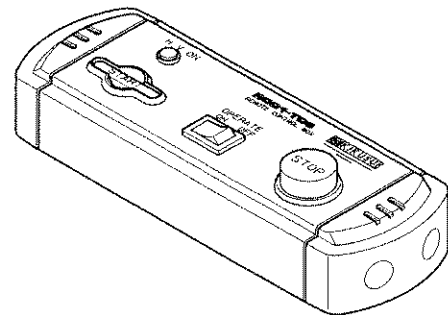

RC01-TOS : 200mm (W) × 70 mm(H) × 39mm (D)

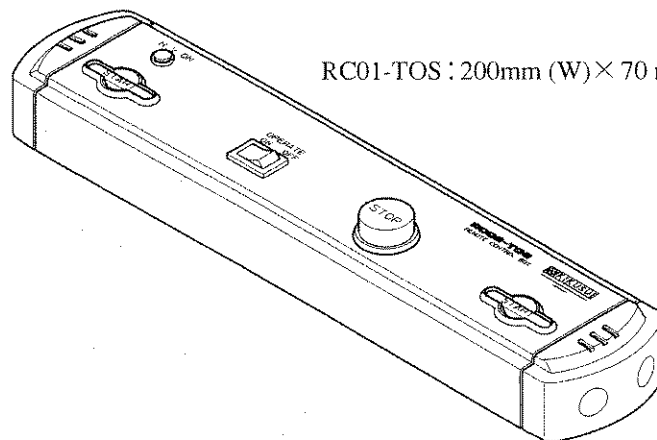

RC02-TOS : 330mm (W) × 70mm (H) × 39mm (D)

■ LTP-2 Test Probe

This probe lets you use the switches located on the probe to control tester start/stop operations. Connect it to the OUTPUT and REMOTE terminals on the tester's front panel.

Cable length: 2 m

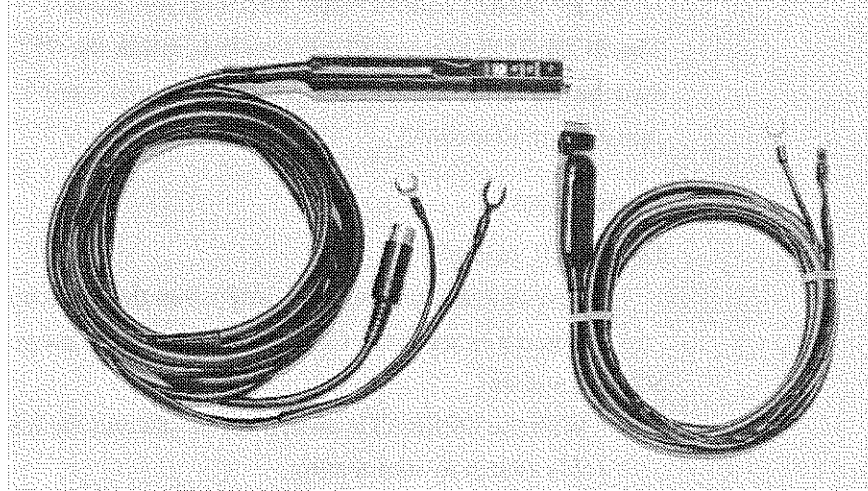

This chapter describes the steps from unpacking of the controller through connection of the AC power cord.

1.1 Unpacking Checks

Upon receiving the product, make sure the package contains the necessary accessories, and that the product has not been damaged during transportation.

If any damage or imperfection is found, contact Kikusui distributor/agent.

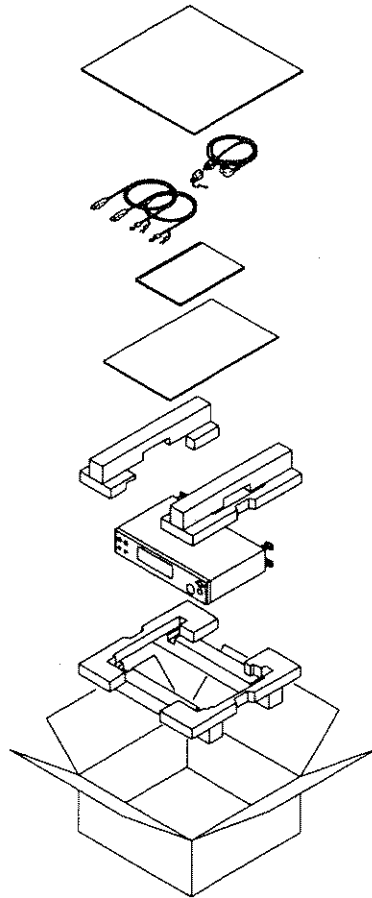

Fig. 1-1 Packing and Unpacking

NOTE

- Packing materials may be used for later transport of the product, so it is recommended that they be retained.
-

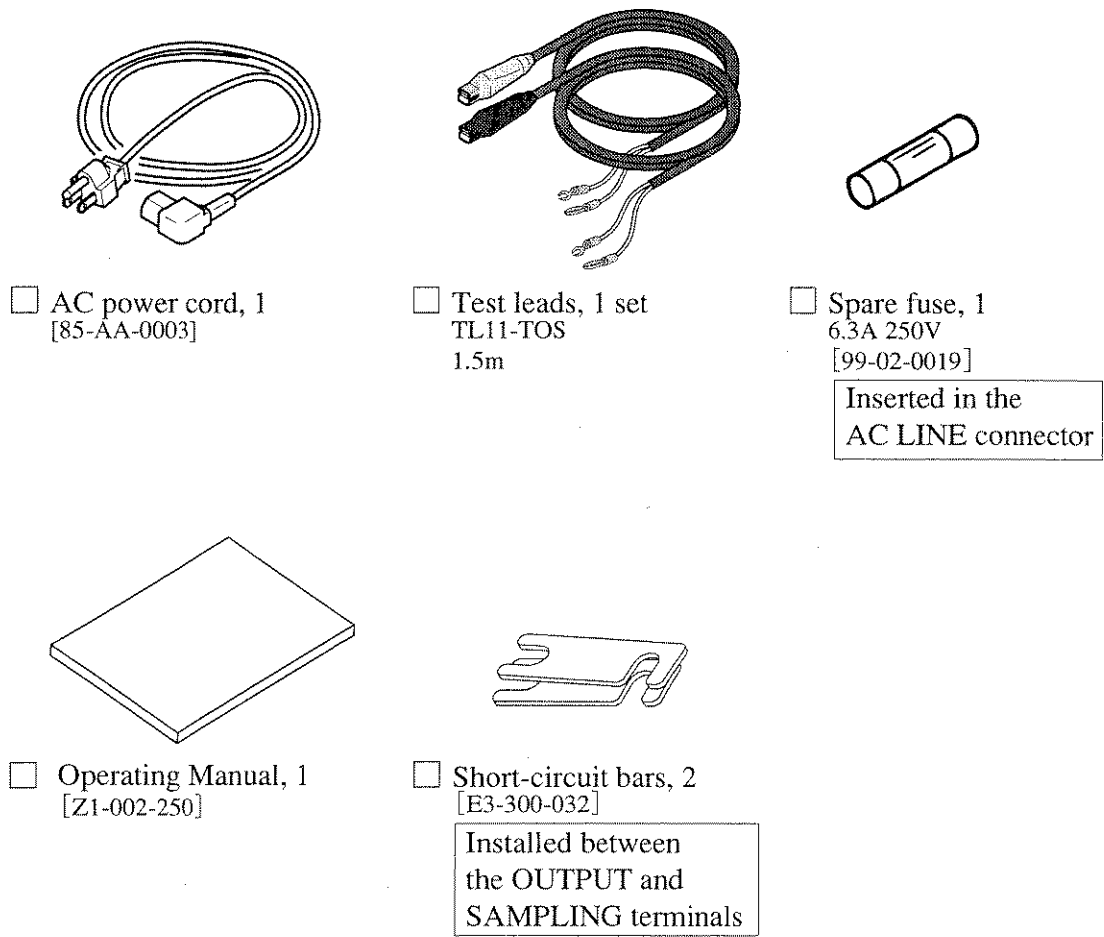

Fig. 1-2 List of Accessories

SIGNAL I/O, GPIB interface, and RS-232C interface cables are not supplied with the product and must be purchased separately.

For information on connecting those cables, see 3.2, SIGNAL I/O Connector, and Chapter 4, GPIB and RS-232C.

1.2 Precautions for installation

Be sure to observe the following precautions when installing the product.

■ **Do not use the product in a flammable atmosphere.**

To prevent explosion or fire, do not use the product near alcohol, thinner, or other combustible materials, or in an atmosphere containing such vapors.

■ **Avoid locations where the product is exposed to high temperatures or direct sunlight.**

Do not locate the product near a heater or in areas subject to drastic temperature changes.

Operating temperature range: 5°C to 35°C
Storage temperature range: -20°C to +70°C

■ **Avoid humid environments.**

Do not locate the product in a high-humidity environment—near a boiler, humidifier, or water supply.

Operating humidity range: 20% to 80% R.H (no dew condensation is allowed)

Storage humidity range: 90% R.H or less (no dew condensation is allowed)

Condensation may occur even within the operating humidity range. In that case, do not start using the product until the location is completely dry.

■ **Do not place the product in a corrosive atmosphere.**

Do not install the product in a corrosive atmosphere or one containing sulfuric acid mist or the like. This may cause corrosion of various conductors and imperfect contact with connectors, leading to malfunction and failure, or in the worst case, a fire.

■ **Do not locate the product in a dusty environment.**

Dirt and dust in the product may cause electrical shock or fire.

■ **Do not use the product where ventilation is poor.**

Prepare sufficient space around the product. Otherwise, heat may accumulate in the product, resulting in fire.

■ **Do not place any object on the product.**

Particularly a heavy one, as doing so could result in a malfunction.

■ **Do not place the product on a tilted surface or in a location subject to vibrations.**

If placed on a non-level surface or in a location subject to vibration, the product may fall, resulting in damage and injury.

- **Do not use the product in locations affected by strong magnetic or electric fields.**

Operation in a location subject to magnetic or electric fields may cause the product to malfunction, resulting in electrical shock or fire.

1.3 Precautions for moving

When moving or transporting the product to an installation site, observe the following precautions.

- **Turn the POWER switch off.**

Moving the product with the power on may result in electrical shock or damage.

- **Remove all wirings connected.**

Moving the product with cables connected may break the cables or cause the product to fall, resulting in injury.

- **For transportation, use the special packing material for the product.**

Transport the product in its original package to prevent vibration and falls, which may damage the product.

If you require packing material, contact Kikusui distributor/agent.

1.4 For Long and Trouble-free Service Life

The heat radiation capacity at the output section is designed to be half the rated output, taking into account size, weight, cost, and other factors. If you perform earth continuity tests for test currents exceeding 15 A, provide pause time at least identical with test times. Allow the device to rest for a period exceeding the test time.

The maximum test time is 30 minutes (at an ambient temperature of 40 °C). If the tester is used for longer periods, the temperature at the output section may rise excessively, tripping an internal safety circuit. If this happens, stop testing long enough for internal temperatures to drop to normal levels.

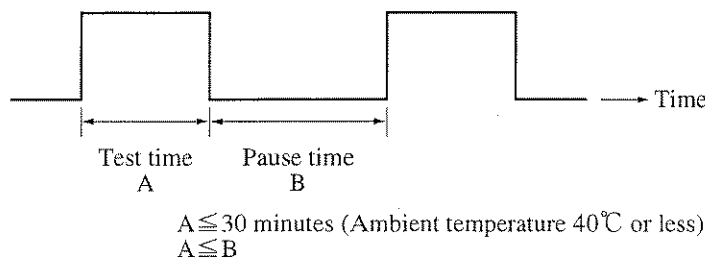

Fig. 1-3 Test time

1.5 Checking the Line Voltage

⚠ WARNING

- This product is designed to be connected to a general-purpose electrical outlet.
- Before switching on power, always check that the power source matches the allowable line voltage range indicated on the rear panel of the tester.

LINE VOLTAGE RANGE	FREQUENCY RANGE	FUSE (250V)		VA MAX
		UL198G	IEC60127	
● 85-132V	45-65Hz	6.3A SLOW	6.3A (T)	450
170-250V				330

The ● symbol indicates the allowable line voltage range. If this symbol is placed by both line voltage ranges, the tester may be used at either line voltage.

The line voltage range for the table above is as follows:

Allowable line voltage range: 85 V to 132 V AC

Allowable frequency range: 45 to 65 Hz

Using the tester outside the permitted range will result in erratic function or failure.

1.6 Connecting the AC Power Cord

⚠ WARNING

- Check the input line voltage range indicated in the LINE VOLTAGE RANGE table on the rear panel before connecting the AC power cord to the tester.

Procedure

1. Check that the power supply falls within the input line voltage range indicated on the tester.
2. Check that the POWER switch of the tester is set to OFF.
3. Connect the AC power cord to the AC LINE connector on the rear panel of the tester.
4. Connect the other end of the AC power cord to an electrical outlet.

1.7 Grounding

⚠ WARNING

- Failure to ground the tester may cause electric shock.
- The product is a class-I device (indicating that electric shock preventing depends on both protective grounding and basic insulation). Always connect the ground terminal to an electrical ground (safety ground) or ground.

Never use the tester without grounding it.

There are two ways to ground the tester, as given below.

1. Connect the AC power cord to a three-contact grounded electrical outlet.

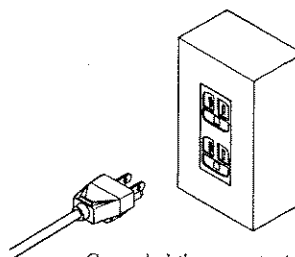

2. Connect the protective ground terminal on the rear panel of the tester directly to ground. Selection, preparation, and installation of grounding leads must be performed by qualified personnel.

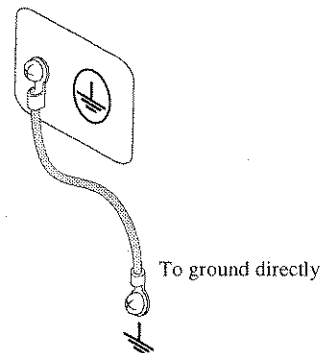

1.8 Connecting the Test Leads

⚠ WARNING

- While this product generates voltages as low as 6 V or less AC, it carries a maximum current flow of 30 A. Always check to make sure that no connections are loose. Loose connection will result in overheating of the OUTPUT terminals or the DUT (Device Under Test), which may then result in burns or injury.
- Never connect the voltage measurement line (thin wire) of the supplied test leads or optional test probe to the OUTPUT terminals. The nominal sectional area of this wire is inadequate for such currents, and burning may result.
- If you plan to prepare the leads yourself, select wires for current output having nominal sectional areas of 5.5 mm² or greater.

⚠ CAUTION

- This product carries a large current and consequently generates a strong magnetic field. Make sure that no articles that may be affected by magnetic fields are located near the test leads or current output lines. For example, images on a CRT positioned close by may be significantly distorted.

1.8.1 Supplied Test Lead TL11-TOS

1. Remove the short-circuit bars connecting the OUTPUT and SAMPLING terminals.
2. Connect the current output line on the crimp terminal side of the test lead (black) to the LOW side of the OUTPUT terminals; connect the voltage measurement line on the banana plug side to the LOW side of the SAMPLING terminals. Check that the connections are secure.
3. Connect the current output line on the crimp terminal side of the test lead (red) to the HIGH side of the OUTPUT terminals; connect the voltage measurement line on the banana plug side to the HIGH side of the SAMPLING terminals. Check that the connections are secure.

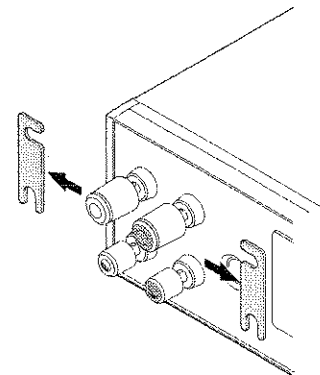

⚠ WARNING

- Improper terminal connections can result in inaccurate measurements and burns or injury resulting from heat generated by contact resistance at the terminals.

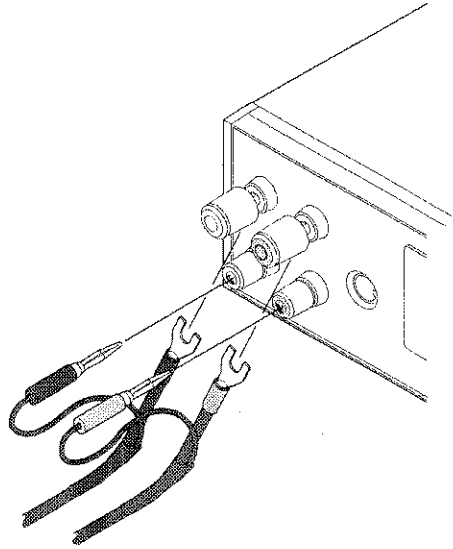

4. Connect the alligator clip of the test lead (black) to the protective grounding terminal of the DUT.
5. Connect the alligator clip of the test lead (red) to a test point of the DUT.
For details, see 1.8.6, Connecting to the DUT.

⚠ CAUTION

- Make sure that the alligator-clip connections are secure. Improper connections may result in clip disconnection, causing sparking and potentially damaging the DUT.
-

1.8.2 Optional Test Probe

⚠ WARNING

- Never connect the voltage measurement line (thin wire) of the optional LTP-2 test probe to the OUTPUT terminals. Its nominal sectional area is inadequate for such currents, and burning may occur.
- Improper terminal connections can result in inaccurate measurements and burns or injury resulting from heat generated by contact resistance at the terminals.

■ LTP-2

1. Remove the short-circuit bars connecting the OUTPUT and SAMPLING terminals.
2. Connect the thick current output line of the test lead to the LOW side of the OUTPUT terminals; connect the thin voltage measurement line of the test lead to the LOW side of the SAMPLING terminals. Make sure that all connections are secure.
3. Connect the thick current output line of the test probe to the HIGH side of the OUTPUT terminals; connect the thin voltage measurement line of the probe to the HIGH side of the SAMPLING terminals. Make sure that all connections are secure.

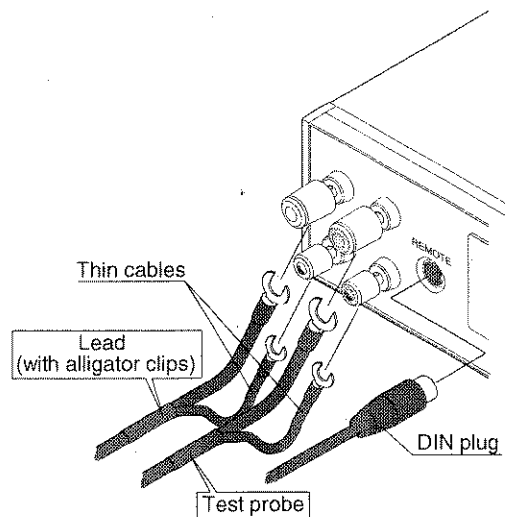

4. Connect the DIN plug of the test probe to the REMOTE terminal.
5. Connect the alligator clip of the test lead to the protective grounding terminal of the DUT.
6. Allow the end of the test probe to touch a test point of the DUT.
For additional information, see 1.8.6, Connecting to the DUT.

⚠ CAUTION

- Make sure that the end of the test probe and test lead alligator clip contact/connect securely.
Improper contact or connection may result in clip disconnection, causing sparking and potentially damaging the DUT.

1.8.3 Other Leads

⚠ WARNING • If you plan to prepare the lead wires yourself, select those with nominal sectional areas of 5.5 mm² or greater for use as current output wires.

⚠ CAUTION • To avoid generating excessive heat at the connections, use crimp terminals appropriate for the sectional area of the current output line.

The resistance for a nominal sectional area of 5.5 mm² is approximately 3.5 mΩ per meter. Use leads no longer than 10 m.

1.8.4 Measurements Using Four Terminals

Four-terminal measurements allow the tester to measure the resistance of the DUT, excluding the minute resistance of the leads, contact resistance of the OUTPUT terminals, and other non-essential characteristics.

Remove the short-circuit bars connecting the OUTPUT and SAMPLING terminals and connect the leads as shown in Fig. 1-4. Sampling the voltage between A and B allows the tester to measure the resistance between A and B without interference from the effects of contact resistance r1 to r8 and resistance R1 to R4 of the leads.

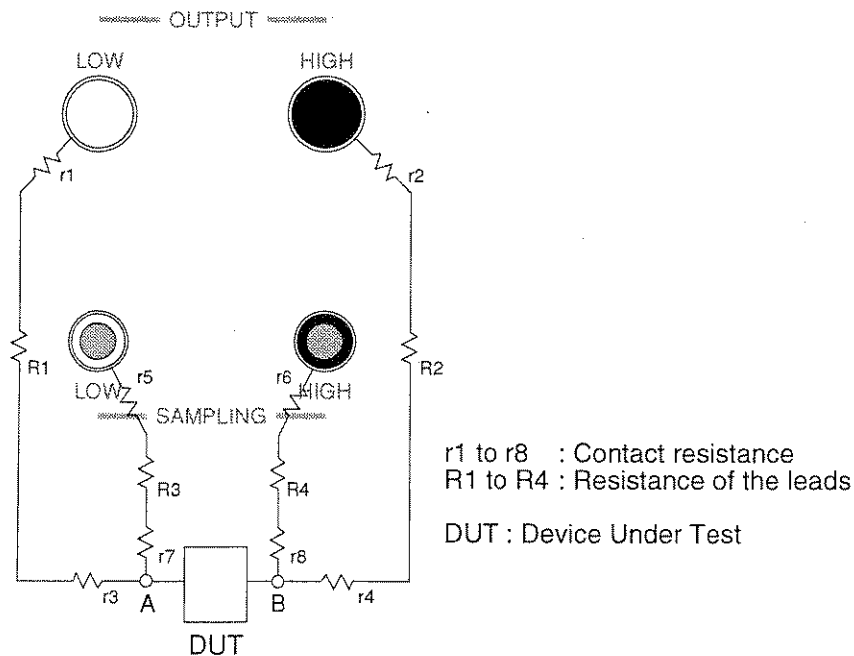

Fig. 1-4 Four-Terminal Connection

1.8.6 Connecting to the DUT



- Connect to the DUT only when the tester status is "ready" ("READY" displayed on the LCD) or "wait" during the contact check (TEST LED blinks).
- To avoid burns, avoid inadvertently touching the testing point or the end of the test probe or lead during the test or immediately after test, since they are at high temperature.

■ Testing from the protective grounding terminal of the AC power inlet

Connect one of the test leads to the protective ground contact of the AC power inlet of the DUT; connect the other test lead to a test point.

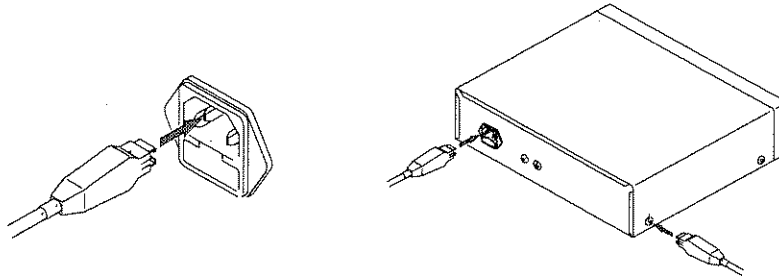

■ Testing from the protective grounding terminal on the enclosure

Connect one of the test leads to the protective grounding terminal of the DUT; connect the other test lead to a test point

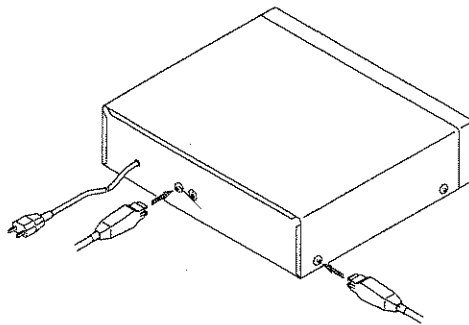

■ Testing from the ground contact of the AC power cord

Connect one of the test leads to the ground contact of the AC power cord of the DUT; connect the other test lead to a test point.

NOTE

- Some safety standards specify excluding the resistance value of the AC power cord protective ground wire from testing. Check the appropriate safety standard to determine if this is the case.

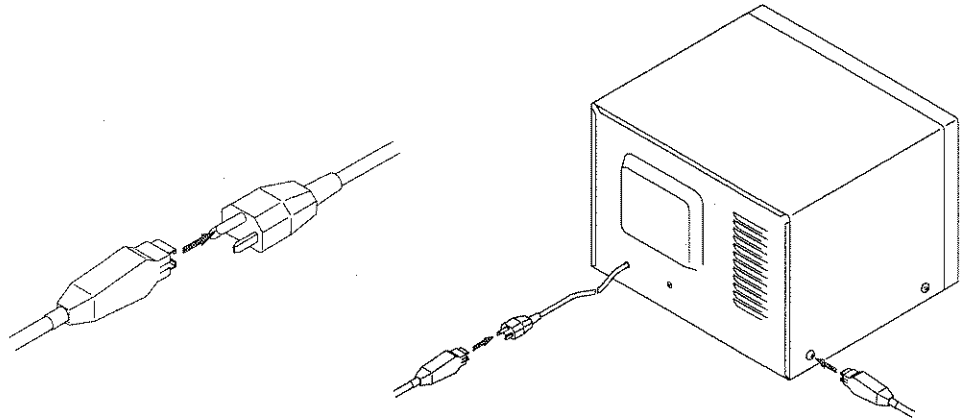

1.9 Preliminary Inspection

Always inspect at least the following points before testing.

- Check that the test lead covers are free of cracks or tears.
- Check that there are no breaks in the test leads.
- Short-circuit the ends of the test leads and test at a specified current to check for abnormalities.
- Perform the test with the OUTPUT terminals opened. This test must result in a FAIL judgement.

2.1 Turning on the power

⚠ WARNING

- Before switching on power, always check that the power source rating matches the allowable voltage range indicated on the rear panel of the tester. For details, see 1.5, Checking the Line Voltage.
- To avoid electric shocks, always turn off the tester before connecting or disconnecting SIGNAL I/O, GPIB, or RS-232C cables.

⚠ CAUTION

- Once you have turn off the POWER switch, wait several seconds before turning it back on. Rapidly turning it off and on may damage the tester.

Power-on Procedure

1. Check that the AC power cord is connected properly.
2. Connect the AC power cord to an electrical outlet.
3. Turn on the tester POWER switch.

Following the opening screen that displays the ROM version and other information on the LCD, the screen displayed when you last turned the POWER switch off appears. When the switch is turned on for the first time after purchase, the following test conditions setup screen (MAIN) is displayed.

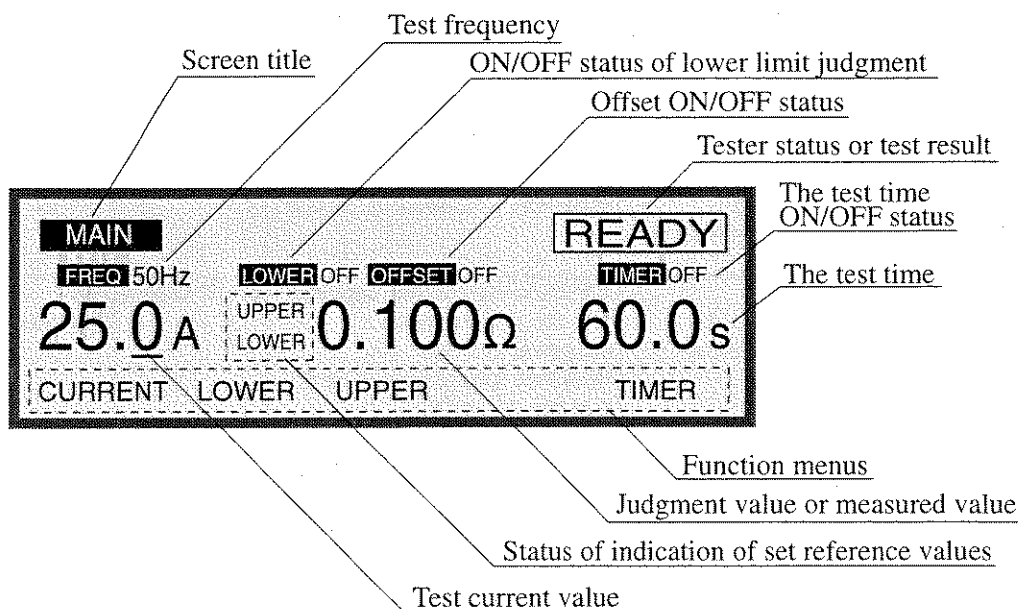

2.2 Setting the Test Conditions

The test conditions are set in the test conditions setup screen (MAIN).

If another screen is displayed, press the MAIN key. The MAIN screen appears on the LCD, and the LED on the MAIN key lights.

Use the ▲▼◀▶ keys to move the cursor to a desired item.

If functions are displayed above the F1 to F5 keys, they may be used to move a cursor directly to a desired item. Holding down with the SHIFT key, press any of keys F1 to F5 to activate the operation indicated above the key.

At factory shipment, settings corresponding to various safety standards are written to memory addresses 1 to 18. For details, see 2.7, Panel Memory, and Appendix 4, Initial Settings of the Memory.

NOTE

- The following table gives excerpts from the safety standards. Before performing actual testing, check the test conditions match your appropriate safety standard.

Standard	Test current	Allowable resistance value	Test time	Remarks
IEC 60065 1998 Audio, Video, and Similar Electronic Apparatus - Safety Requirements	25 A AC or DC (30 A in Canada)	0.1 Ω or less	1 minute	Type test
	Order of 10 A AC	0.1 Ω or less	1 to 4 seconds	Routine test*1
		0.2 Ω or less		Routine test*2
IEC 60204-1 1997 Electrical Equipment of Industrial Machines - Part 1: General Requirements	10 A or more (50 or 60 Hz)	0.1 Ω or equivalent, provided that the test current is 10 A	10 seconds or more	
IEC 60335-1 1994 Safety of Household and Similar Electrical Appliances - Part 1: General Requirements	<1> 25 A DC or 25 A AC or <2> 1.5 times the rated current of device, whichever is greater.	0.1 Ω or less	Not specified	
IEC 60601-1 1995 Medical Electrical Equipment - Part 1: General Requirements for Safety	<1> 25 A (50 or 60 Hz) or <2> 1.5 times the rated current of device, whichever is greater.	0.1 Ω or less	5 to 10 seconds	
IEC 60950 1997 Safety of Information Technology Equipment	1.5 times the current capacity of a circuit generating dangerous voltage. Note that current should be 25 A or less AC or DC.	0.1 Ω or less	Not specified	
IEC 61010-1 1995 Safety Requirements for Electrical Equipment for Measurement, Control and Laboratory use - Part 1:General Requirements	<1> 25 A DC or 25 A AC (at power supply's rated frequency) or <2> 2 times the rated current of device, whichever is greater.	0.1 Ω or less	1 minute	Type test
UL1492 1993 Audio-Video Products and Accessories	60 Hz, 20 A	0.1 Ω or less	Not specified	Type test

Standard	Test current	Allowable resistance value	Test time	Remarks
UL1950 1998 Safety of Information Technology Equipment	1.5 times the current capacity of a circuit generating dangerous voltage. Note that it should be 25 A or less AC or DC.	0.1 Ω or less	Not specified	
UL2601-1 1997 Medical Electrical Equipment - Part 1: General Requirement for Safety	<1> 25 A (50 or 60 Hz) or <2> 1.5 times the rated current of device, whichever is greater.	0.1 Ω or less	5 to 10 seconds	*1
		0.2 Ω or less		*2
UL3111-1 1994 Electrical Measuring and Test Equipment - Part 1: General Requirements	<1> 25 A DC or 25 A AC (at power supply's rated frequency) or <2> 2 times the rated current of device, whichever is greater.	0.1 Ω or less	1 minute	Type test
UL6500 1998 Standards for Safety for Audio/Video and Musical Instruments Apparatus for Household, Commercial, and Similar General Use.	25 A AC or DC (30 A in Canada)	0.1 Ω or less	1 minute	Type test
Electrical Appliance and Material Control Law of Japan	15A	0.1 Ω or equivalent, provided that the test current is 15 A	Not specified	
JIS T 1001 1992 General Requirements for Safety of Medical Electrical Equipment JIS T 1002 1992 General Rules of Testing Methods for Safety of Medical Electrical Equipment	50 or 60 Hz, 10 A to 25 A	0.1 Ω or less	5 seconds or more	*1
		0.2 Ω or less		*2
JIS T 1022 1996 Safety Requirements of Electrical Installations for Medically Used Rooms in Hospitals and Clinics	10 A to 25 A	0.1 Ω or less	Not specified	

*1: Equipment equipped with removable AC power cord.

*2: Equipment equipped with fixed AC power cord.

2.2.1 Setting Test Current

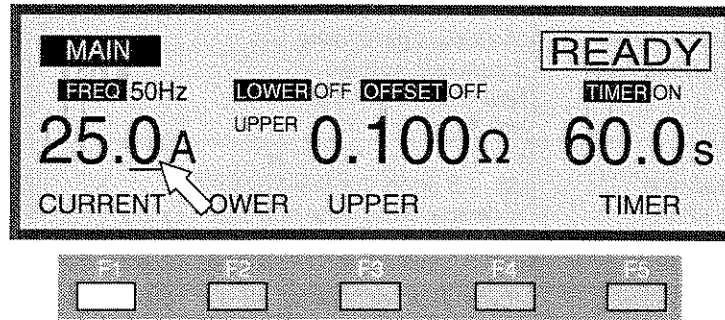

Set the maximum current value flowing through the DUT in the range 3.0 A to 30.0 A (resolution: 0.1 A). If the cursor is below the test current value, adjust it with the rotary knob.

NOTE

- The test current setting range for the tester is within 3 A to 30 A AC when the resistance value is such that the output power is less than the maximum rated output and the output terminal voltage is 5.4 V or less. Thus, for settings for which the product of the test current value and upper reference value (including the offset value, when the OFFSET is ON) exceeds 5.4 V, the tester turns off the READY indication and blinks the OVER VOLT indication instead. This informs the operator that the test cannot be carried out.

If the output power exceeds a maximum power rating of 150 VA during testing, the power limitation safety function is tripped and protection status occurs.

Set test current and upper reference values within this setting range.

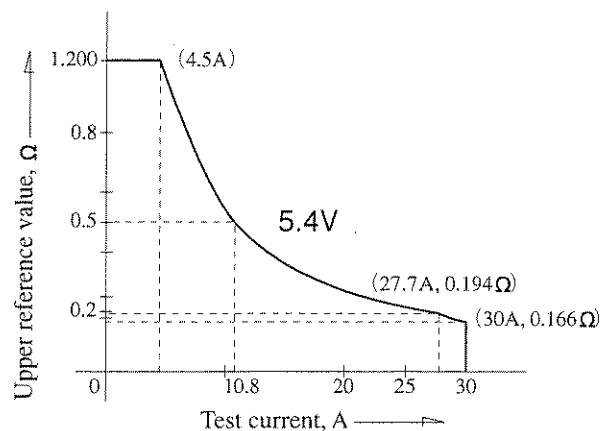

- The current value may be changed even during testing. To avoid rapid changes, current value must be changed by increasing or decreasing the least significant digit (the cursor is fixed at the least significant digit).

If the test current is changed when the resistance value is close to the upper reference value, a FAIL status may occur.

1. Press the F1 (CURRENT) key to move the cursor to the test current value if it is not already there (you can also move the cursor using the ▲▼◀▶ keys).
2. Use the ◀▶ keys to move the cursor below a digit to be set.
3. Set a test current value with the rotary knob.

2.2.2 Setting Test Frequency

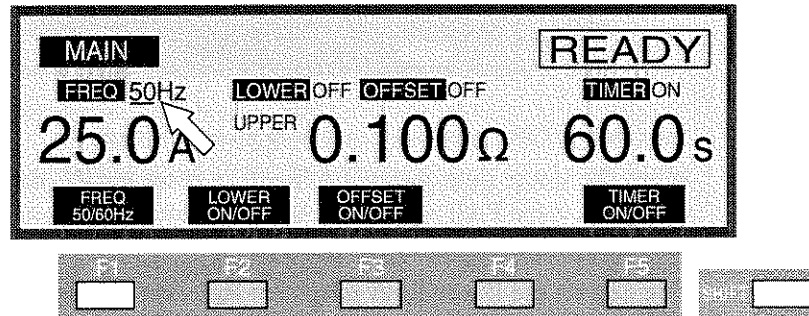

Select the frequency of the test current, 50 or 60 Hz.

You can set the test frequency using the SHIFT + F1 key combination (pressing the F1 key while holding down the SHIFT key), regardless of cursor position. Pressing SHIFT + F1 toggles between 50 Hz and 60 Hz settings.

You can also use the ▲▼◀▶ keys to move the cursor to the test frequency indication.

With the cursor at the test frequency indication, use the rotary knob to set.

Turning the knob clockwise: 60 Hz

Turning the knob counterclockwise: 50 Hz

2.2.3 ON/OFF of Lower Limit Judgment

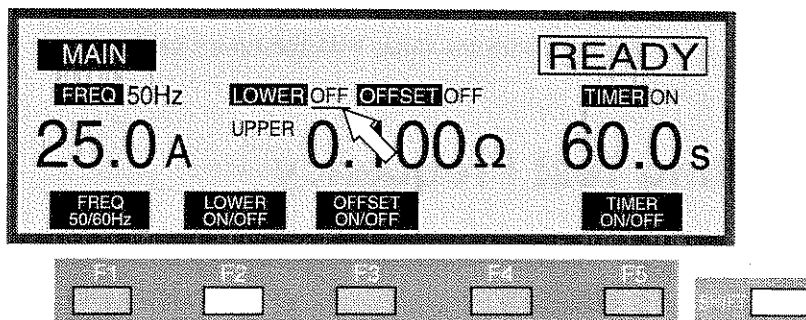

Set ON/OFF for the lower limit judgment function.

When the lower limit judgment function is set to ON, the tester returns a measured resistance value FAIL if it drops below the lower reference value - which is set in the next subsection - terminating the test.

You can set the lower limit judgment function ON/OFF using the SHIFT + F2 key combination (pressing the F2 key while holding down the SHIFT key), regardless of cursor position. Pressing SHIFT + F2 toggles between ON and OFF.

You can also use the ▲▼◀▶ keys to move the cursor to the ON/OFF indication for the lower limit judgment function. Use the rotary knob to set to ON or OFF.

Turning the knob clockwise: ON

Turning the knob counterclockwise: OFF

2.2.4 Setting the Lower Reference Value

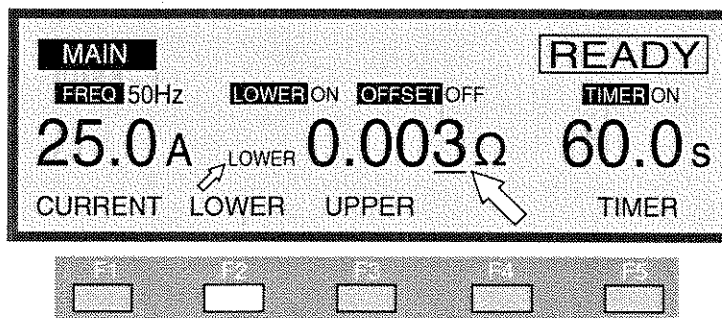

The lower reference value may be set in the range 0.001 to 1.200 Ω (resolution: 0.001 Ω). With the cursor below the lower reference value, use the rotary knob to set a value.

1. Press the F2 (LOWER) key if the lower reference value is not displayed on the LCD. (You can also use the ▲▼◀▶ keys to move the cursor when the lower reference value is displayed.)
2. Use the ◀▶ keys to move the cursor to the desired digit.
3. Use the rotary knob to set a lower reference value.

NOTE

- If you set a lower reference value above the upper reference value while the lower limit judgment function is ON, the tester turns off the READY indication and blinks the "UP<=LOW" indication instead in the upper right part of the LCD. This informs the operator that the test cannot be performed. (The lower reference value is factory-set to 0.001 Ω .)

In this case, reduce the lower reference value or increase the upper reference value.

2.2.5 Setting the Upper Reference Value

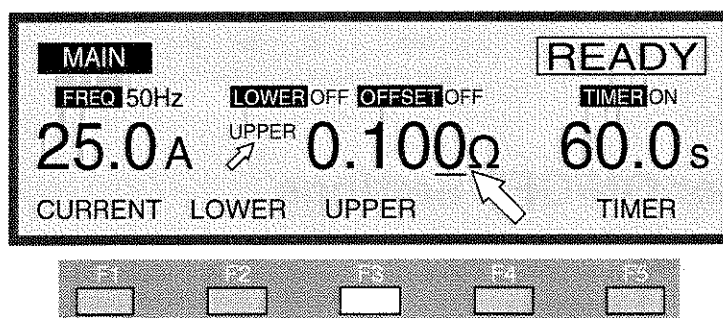

You can set an upper reference value in the range 0.001 to 1.200 Ω (resolution: 0.001 Ω). With the cursor below the upper reference value, use the rotary knob to set a value.

1. Press the F3 (UPPER) key if the upper reference value is not displayed on the LCD. (You can also use the \blacktriangle \blacktriangledown \blacktriangleleft \blacktriangleright keys to move the cursor when the upper reference value is displayed.)
2. Use the \blacktriangleleft \blacktriangleright keys to move the cursor to the desired digit.
3. Use the rotary knob to set an upper reference value.

NOTE

- If you set a upper reference value below the lower reference value while the lower limit judgment function is ON, the tester turns off the READY indication and blinks the "UP<=LOW" indication instead in the upper right part of the LCD. This informs the operator that the test cannot be performed. (The lower reference value is factory-set to 0.100 Ω .)

In this case, increase the upper reference value or reduce the lower reference value.

- The test current setting range for the tester is within 3 A to 30 A AC when the resistance value is such that the output power is less than the maximum rated output and the output terminal voltage is 5.4 V or less. Thus, for settings for which the product of the test current value and upper reference value (including the offset value, when the OFFSET is OFF) exceeds 5.4 V, the tester turns off the READY indication and blinks the OVER VOLT indication instead. This informs the operator that the test cannot be carried out.

If the output power exceeds a maximum power rating of 150 VA during testing, the power limitation safety function is tripped and protection status occurs. Set test current and upper reference values within this setting range.

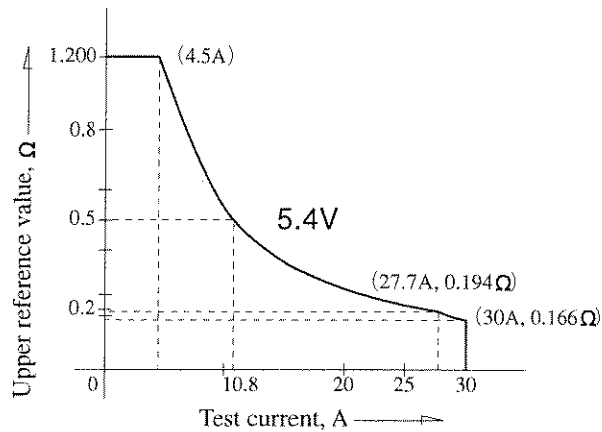

2.2.6 Timer ON/OFF Settings

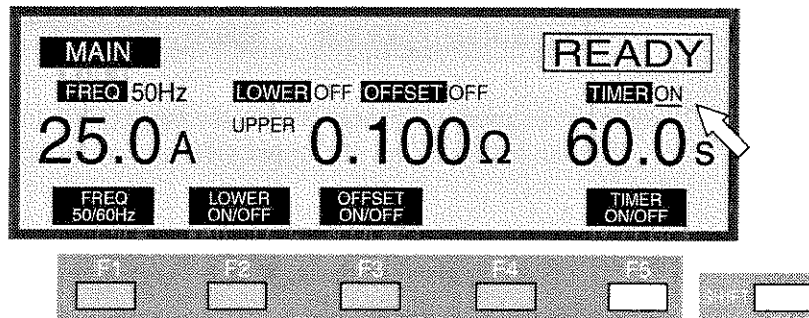

Set the timer function ON or OFF.

When the timer function is set to ON, you can control the duration of testing by setting the test time as in 2.2.7, Setting the Test Time. When the set time elapses with the resistance value within the upper and lower reference values during testing, the tester returns a PASS and ends the test.

You can set the timer function ON/OFF setting using the SHIFT + F5 key combination (pressing the F5 key while holding down the SHIFT key), regardless of cursor position. Pressing SHIFT + F5 toggles between ON and OFF.

You can also use the ▲▼◀▶ keys to move the cursor to the timer function ON/OFF indicator. Use the rotary knob to set to ON or OFF.

Turning the knob clockwise: ON

Turning the knob counterclockwise: OFF

2.2.7 Setting the Test Time

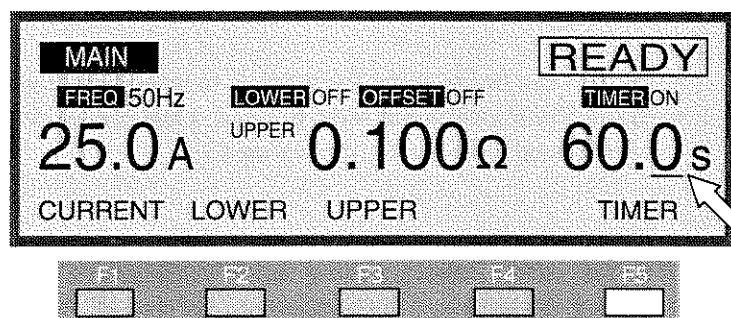

You can set a testing duration anywhere in the range 0.3 s to 999 s (resolution of 0.1 s for 0.3 s to 99.9 s and 1 s for 100 s to 999 s).

With the cursor below the timer, use the rotary knob to set.

1. Press the F5 (TIMER) key to move the cursor if the cursor is not below the timer (you can also move the cursor using the ▲▼◀▶ keys).
2. Use the ◀▶ keys to move the cursor to the desired digit.
3. Use the rotary knob to set the test duration.

2.2.8 Offset Canceling Function ON/OFF Settings

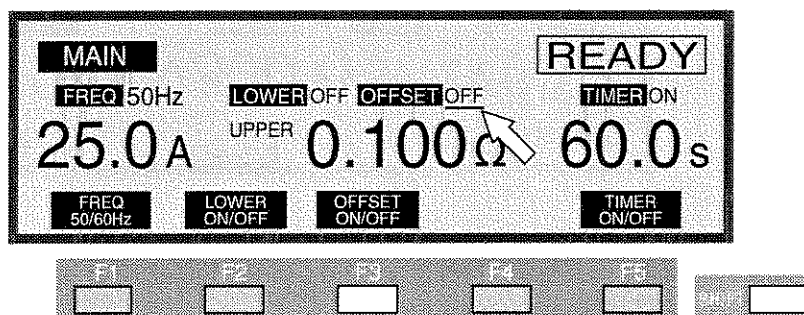

Set the offset canceling function ON or OFF.

With the offset canceling function set to ON, the tester display the resistance value obtained after subtracting the offset value set in 2.4 Offset Canceling Function from the measured value.

You can use the SHIFT + F3 key combination (pressing the F3 key while holding down the SHIFT key) to set the offset canceling function ON or OFF, regardless of cursor position. Pressing SHIFT + F3 toggles between ON and OFF.

You can also use the ▲▼◀▶ keys to move the cursor to the OFFSET ON/OFF indication. Use the rotary knob to set to ON or OFF.

Turning the knob clockwise: ON

Turning the knob counterclockwise: OFF

2.3 Starting and Ending Test

NOTE

- No test can begin when the tester is in protection status.
- If the STOP switch has been pressed, a test cannot be started. (This includes stop signals sent from the remote control.)
- When DOUBLE ACTION is set to ON, you can begin the test by pressing the STOP switch, then pressing the START switch within approximately a half-second. Otherwise, the test cannot be started. For information on DOUBLE ACTION, see 2.5, System Setup.
- When MOMENTARY is set to ON, the tester performs the test only while the START switch is being held down. For more information on MOMENTARY, see 2.5, System Setup.

2.3.1 Starting a Test

To begin testing, press the START switch while the MAIN screen indicates ready. In the ready status, the upper right part of the LCD indicates "READY".

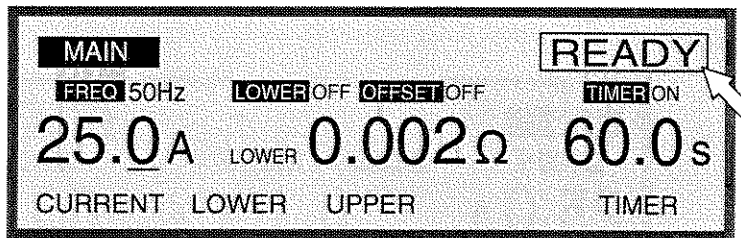

When the test starts, the LCD screen changes to display the following:

During testing, "TEST" appears in the upper right part of the LCD and the TEST LED indicator remains lit.

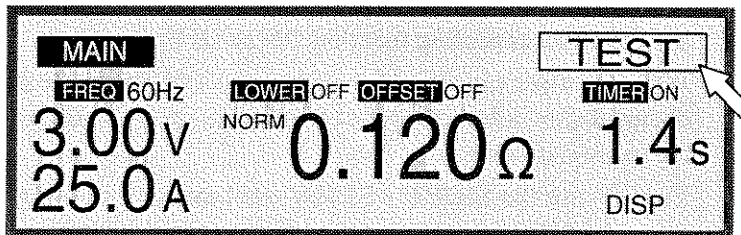

The time indicated after start of the test differs with the timer function set to ON or OFF.

When the timer is ON: The time remaining of the set time is indicated.

When the timer is OFF: The elapsed test duration is indicated.

(Note: When the time exceeds 999 seconds, "999" blinks.)

You can change the test current with the rotary knob during a test. Note that the value should fall within the upper and lower limits.

The test current cannot be changed if the key lock function is activated.

NOTE

- Changing the test current when the resistance value is close to the upper reference value may precipitate a FAIL status.

During testing, you can change the screen display as follows using the F5 (DISP) key.

DISP 1

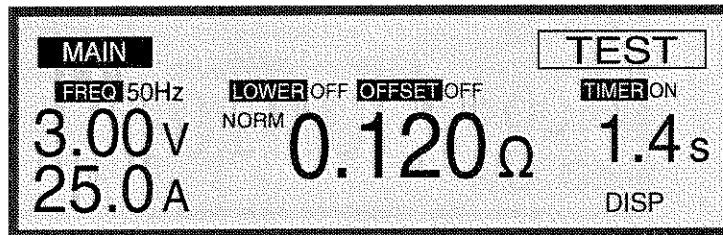

DISP 2

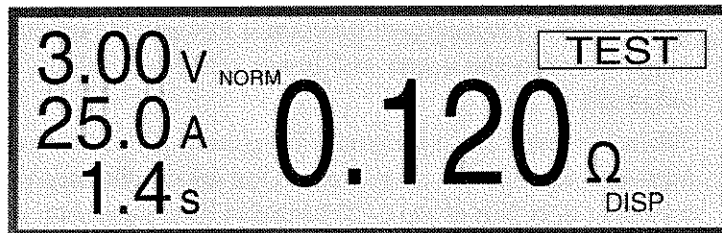

To stop the test, press the STOP switch.

2.3.2 Ending the Test

■ PASS judgment

When the lower limit judgment function is ON and the measured value falls between the upper and lower reference values, the tester returns a PASS judgment.

When the lower limit judgment function is OFF, the tester returns a PASS judgment for the measured value if the value is less than the upper reference value.

When a PASS judgment is returned for the measured value, "PASS" appears in the upper right part of the LCD, the PASS LED indicator lights, and the buzzer sounds. The PASS judgment is generally displayed for about 0.2 seconds (default value). You can set the PASS judgment display time in the range 0.2 s to 10.0 s or to HOLD. For information on altering this setting, see 2.5, System Setup.

When the timer is ON

After the time set in the timer elapses, the tester returns a PASS judgment and reverts to ready status. The measurement result is displayed while "PASS" is displayed.

When the timer is OFF

The test continues as long as the measured value meets the conditions set for a PASS judgment.

To stop the test, press the STOP switch. If the test is terminated by pressing the STOP switch, no judgment is returned for the measured value, and "PASS" is not displayed.

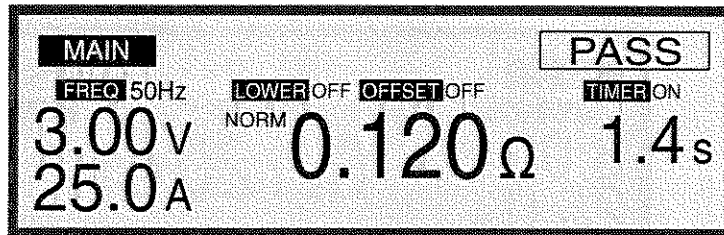

PASS judgment

■ FAIL judgment

If the lower limit judgment function is ON and the measured value falls outside the range between the upper and lower reference values, the tester returns a FAIL judgment.

When the lower limit judgment function is OFF, the tester returns a FAIL for the measured value if the value exceeds the upper reference value. "↓ FAIL" appears in the upper right part of the LCD for lower limit judgment, while "↑ FAIL" appears for Upper limit judgment in the same part. The FAIL LED indicator also lights, and the buzzer sounds.

To remove a FAIL judgment, press the STOP switch. (FAIL judgment indication persists until you press the STOP switch.)

The measurement result is displayed until you press the STOP switch.

In case of FAIL, the test duration indicates the elapsed time regardless of the timer ON/OFF setting.

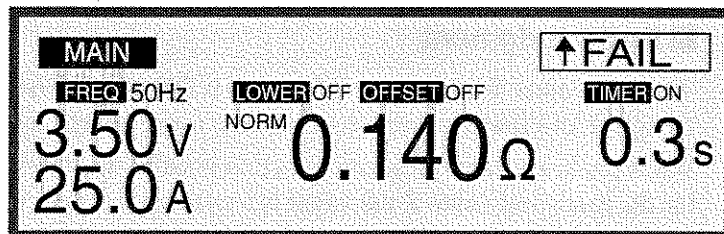

FAIL judgment

2.4 Offset Canceling Function

To measure a resistance value by subtracting the resistance components of lead wires in measurements (when using two terminals or in other cases), first measure an offset.

Measurement Procedure

1. Connect the lead wires whose resistance components are to be measured to the OUTPUT terminals.
2. Short-circuit the ends of the leads connected to the LOW and HIGH terminals of the OUTPUT terminals.
3. Press the SHIFT + MAIN/OFFSET keys (press the MAIN key while holding down the SHIFT key) to invoke the offset measurement screen (OFFSET).

In the OFFSET screen, the test current, test frequency, and timer indicate the values shown before switching screens.

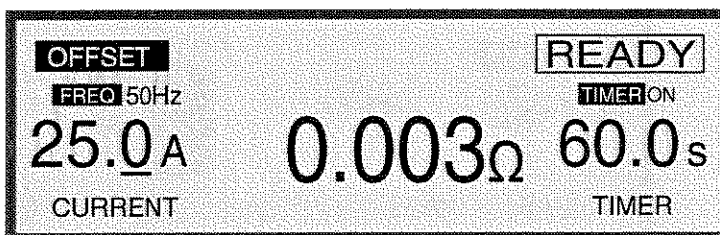

4. If necessary, set test current, test frequency, and timer values.
For information on setting these values, see 2.2, Setting the Test Conditions.
5. When "READY" (ready status) is displayed in the OFFSET screen, press the START switch. This begins offset measurement.

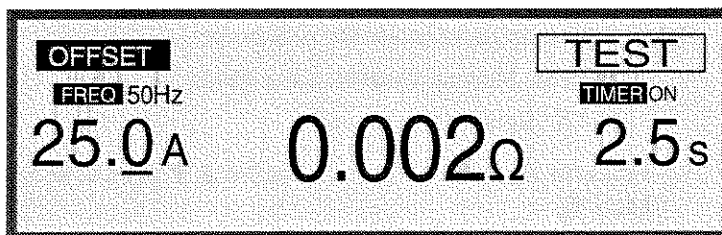

When you press the STOP switch or when the time set in the timer elapses, the tester stores the offset value of that time in memory. When offset measurement ends, the tester reverts to ready status.

Press the MAIN key to display the MAIN screen. Check that the offset function is ON, then begin the test.

To check the offset value, display the OFFSET screen by pressing the MAIN/OFFSET key again while holding down the SHIFT key.

2.5 System Setup

Press the SYSTEM key to display the system setup screen (SYSTEM). The LED on the SYSTEM key will also light.

You can set or enter the following nine items in the SYSTEM screen.

- 1 Setting the measurement mode (MAX., NORMAL)
- 2 Setting the PASS hold time
- 3 ON/OFF for momentary setting
- 4 ON/OFF for fail mode
- 5 ON/OFF for double action
- 6 ON/OFF for contact check
- 7 Setting the buzzer volume
- 8 Setting the contrast
- 9 Entering comments

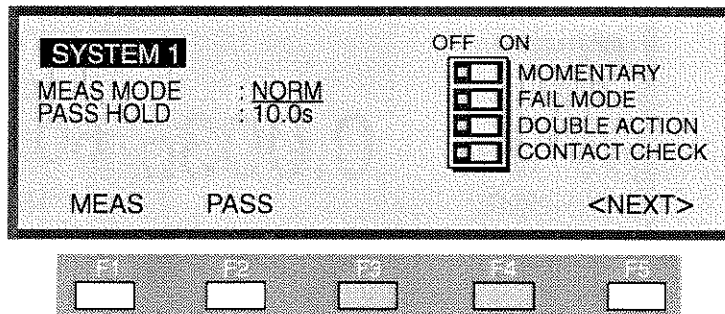

Setting the Measurement Mode (MAX, NORM)

Select a measurement mode for resistance:

NORM: Normal measurement mode

MAX: Retains a peak value

1. Press the F1 (MEAS) key, or use the ▲▼◀▶ keys to move the cursor to MEAS MODE.
2. Use the rotary knob to select either MAX or NORM.

Setting the PASS Hold Time

Set a hold time for PASS judgment between 0.2 s and 10.0 s (resolution: 0.1 s), or set to HOLD.

When PASS HOLD is set to HOLD, the tester retains the PASS judgment until you press the STOP switch.

1. Press the F2 (PASS) key, or use the ▲▼◀▶ keys to move the cursor to PASS HOLD.
2. Use the rotary knob to set a hold time for a PASS judgment..

ON/OFF for Momentary Setting

NOTE

- Releasing the START switch when MOMENTARY is set to ON is the same as pressing the STOP switch. If the step interval has been set to HOLD for program-based automatic testing, the program cannot proceed to the next step.

When MOMENTARY is set to ON, the tester performs a test only as long as the START switch remains depressed. You can set MOMENTARY using the SHIFT + F1 key combination (pressing the F1 key with the SHIFT key held down) regardless of cursor position. Pressing the SHIFT + F1 keys toggles between ON and OFF settings. Here, ► appears to the left of MOMENTARY.

When ► is displayed to the left of MOMENTARY, you can also use the rotary knob to enter ON/OFF settings.

Turning the knob clockwise: ON

Turning the knob counterclockwise: OFF

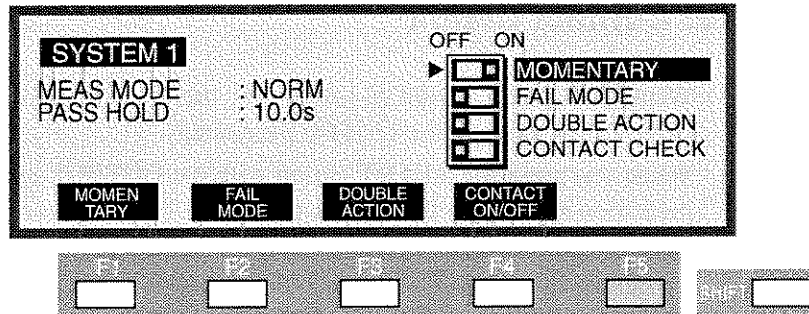

ON/OFF for Fail Mode

With FAIL MODE set to ON, FAIL judgment and protection status cannot be cancelled by a stop signal from the remote control (you can still cancel by pressing the front panel STOP switch).

You can set the fail mode using the SHIFT + F2 key combination (pressing the F2 key with the SHIFT key held down) regardless of cursor position.

Pressing the SHIFT + F2 keys toggles between ON and OFF settings. Here, ► appears to the left of FAIL MODE. When ► is displayed to the left of FAIL MODE, you can also use the rotary knob to enter ON/OFF settings.

Turning the knob clockwise: ON

Turning the knob counterclockwise: OFF

ON/OFF for Double Action

When DOUBLE ACTION is set to ON, you must press the START key within approximately a half-second after the STOP key is pressed to start testing. (The "READY" indication will go out approximately a half-second after the STOP key is pressed.)

You can set DOUBLE ACTION using the SHIFT + F3 key combination (pressing the F3 key with the SHIFT key held down) regardless of cursor position. Pressing the SHIFT + F3 keys toggles between ON and OFF settings. Here, ► appears to the left of DOUBLE ACTION.

When ► is displayed to the left of DOUBLE ACTION, you can also use the rotary knob to enter ON/OFF settings.

Turning the knob clockwise: ON

Turning the knob counterclockwise: OFF

ON/OFF for Contact Check

With CONTACT CHECK set to ON, the tester can start testing by monitoring current flow through the OUTPUT terminals.

When you press the START switch with the OUTPUT terminals opened, a "TEST" indication appears on the LCD, and the TEST LED on the front panel blinks, and the tester enters current monitoring status. When the probe contacts the DUT and causes current to flow, the TEST LED on the panel lights and the tester begins testing, continuing the test until the set time elapses or the STOP switch is pressed.

You can set the contact check using the SHIFT + F4 key combination (pressing the F4 key with the SHIFT key held down) regardless of cursor position. Pressing the SHIFT + F4 keys toggles between ON and OFF settings. Here, ► appears to the left of CONTACT CHECK.

When ► is displayed to the left of CONTACT CHECK, you can also use the rotary knob to enter ON/OFF settings.

Turning the knob clockwise: ON

Turning the knob counterclockwise: OFF

-
- ⚠ CAUTION** • After testing starts, sparking will occur if the probe is separated from the DUT and then recontacts it, potentially damaging the DUT or probe. Separate the probe from the DUT only after pressing the STOP switch.
-

Setting the Buzzer Volume

You can set the volume for the buzzer that sounds in case of a FAIL judgment in the range from 1 to 10 (resolution: 1). The volume of the buzzer for a PASS judgment is approximately half that of a FAIL judgment.

1. If BUZZER VOL is not indicated on the LCD, press the NEXT or PREV function key to display the SYSTEM2 screen.
2. Press the F1 (BUZZER) key, or use the ▲ ▼ keys to move the cursor to BUZZER VOL. Press the F1 (BUZZER) key to hear the buzzer sound set.
3. Use the rotary knob to set the buzzer volume.

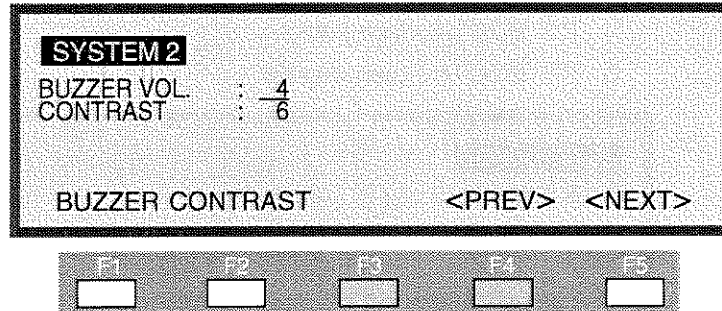

Setting the Contrast

You can set the LCD screen contrast in the range from 1 to 10 (resolution: 1).

1. If CONTRAST is not indicated on the LCD, press the NEXT or PREV function key to display the SYSTEM2 screen.
2. Press the F2 (CONTRAST) key, or use the ▲ ▼ keys to move the cursor to CONTRAST.
3. Use the rotary knob to set contrast.

You can set contrast with the SHIFT + ▲ ▼ key combination (pressing the ▲ or ▼ key with the SHIFT key held down) in any screen.

Entering Comments

You can enter up to 20 characters per line x 3 lines worth of comments (ASCII codes 20H to 7EH; see Appendix 2).

1. If COMMENTS is not indicated on the LCD, press the NEXT or PREV function key to display the SYSTEM3 screen.
2. Use the ▲ ▼ ◀ ▶ keys to move the cursor to the position where you wish to enter a comment.
3. Use the rotary knob to select characters.

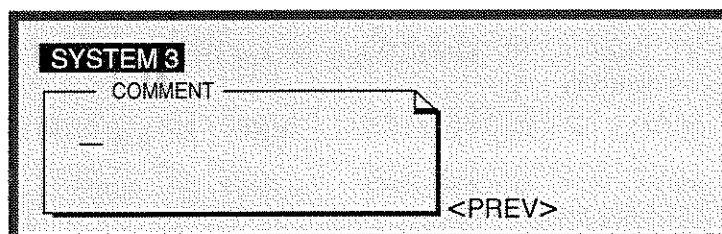

2.6 Interface Setup

Press the SHIFT + SYSTEM / I/F key combination (pressing the SYSTEM key with the SHIFT key held down) turns on the LED for the SYSTEM / I/F key lights up and displays the interface setup screen (INTERFACE).

You can set the following five items in the INTERFACE screen.

- 1 GPIB address
- 2 RS-232C interface communications rate
- 3 RS-232C interface data length
- 4 RS-232C interface parity
- 5 RS-232C interface stop bit

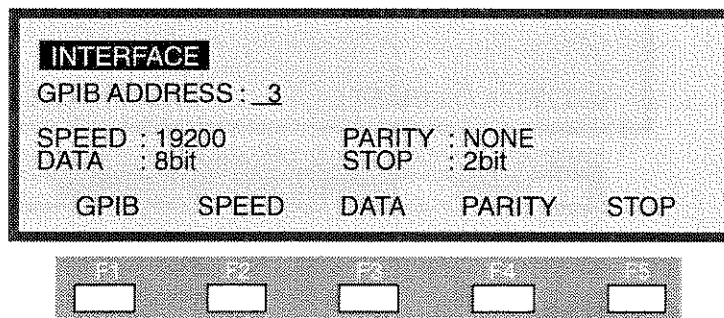

Setting the GPIB Address

Set the GPIB address of the tester in the range from 0 to 30.

NOTE

- The GPIB address set is not effective until the tester is restarted.

1. Press the F1 (GPIB) key, or use the ▲ ▼ ◀ ▶ keys to move the cursor to GPIB ADDRESS.
2. Use the rotary knob to set the GPIB address.

Setting the RS-232C interface communications rate

Select an RS-232C interface communications rate from the three following choices.

- 38400 bps
- 19200 bps
- 9600 bps

1. Press the F2 (SPEED) key, or use the ▲ ▼ ◀ ▶ keys to move the cursor to SPEED.
2. Use the rotary knob to select 38400, 19200, or 9600 bps.

Setting the RS-232C Interface Data Length

Select an RS-232C interface data length from the following two choices:

7 bit

8 bit

1. Press the F3 (DATA) key, or use the ▲▼◀▶ keys to move the cursor to DATA.
2. Use the rotary knob to select either 7 or 8.

Setting the RS-232C Interface Parity

Select an RS-232C interface parity from the following three choices:

NONE

ODD

EVEN

1. Press the F4 (PARITY) key, or use the ▲▼◀▶ keys to move the cursor to PARITY.
2. Use the rotary knob to select NONE, ODD, or EVEN.

Setting the RS-232C Interface Stop Bit

Select an RS-232C interface stop bit from the following two choices:

1 bit

2 bit

1. Press the F5 (STOP) key, or use the ▲▼◀▶ keys to move the cursor to STOP.
2. Use the rotary knob to select either 1 or 2.

2.7 Panel Memory

The tester can store up to 100 currently set test conditions in its internal memory, allowing you to store test conditions for the following six items.

- Test current
- Frequency
- Lower limit judgment (including ON/OFF setting)
- Upper limit judgment
- Timer (including ON/OFF setting)
- Measured offset value (including ON/OFF setting)

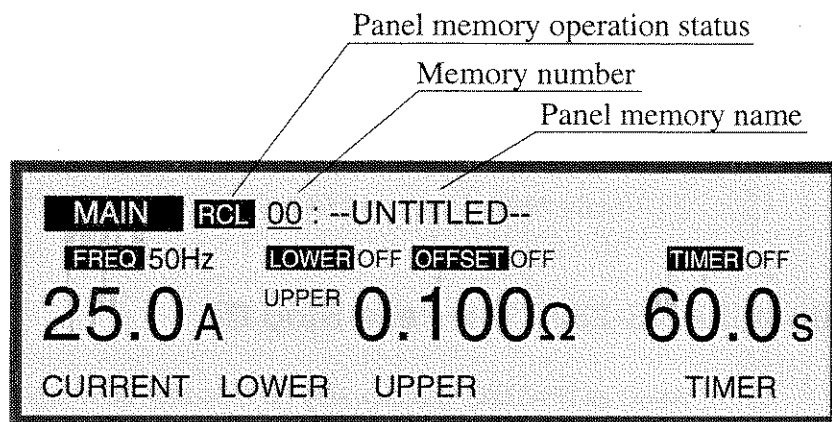

On shipment from the factory, settings corresponding to a variety of safety standards are written to memory addresses 1 to 18. For these settings, see Appendix 4, Initial Settings of the Memory.

2.7.1 Storing in the Panel Memory

NOTE

- To store test conditions, first determine the memory number, then enter the name as shown below. Moving the cursor to the memory number after setting a name restores the entered name to the previous name.

1. Press the MAIN key to display the MAIN screen and set test conditions.
2. Press the RECALL/STORE key with the SHIFT key held down. This displays the indication "STO*:*:--UNTITLED--" to the right of the screen title.
3. Use the rotary knob to set the memory number (from 00 to 99) to which test conditions are to be stored.
4. Press the ► key to move the cursor to "--UNTITLED--."

5. Use the rotary knob to enter a memory name.
ASCII code characters from 20 H to 7EH are valid. (See Appendix 2.)
6. Press the ENTER key to store the test conditions to this memory number.
After the conditions are stored, the letters "STO" will change on the LCD to "MEM."

Moving the cursor to another area before pressing the ENTER key will abort the storage operation.

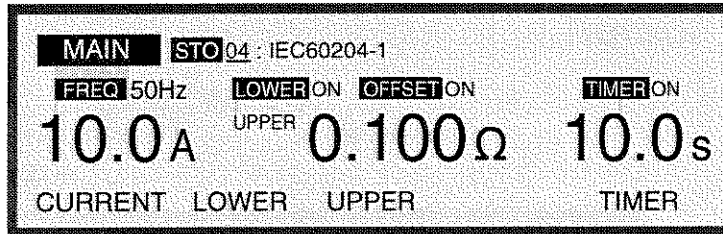

2.7.2 Recalling the Panel Memory

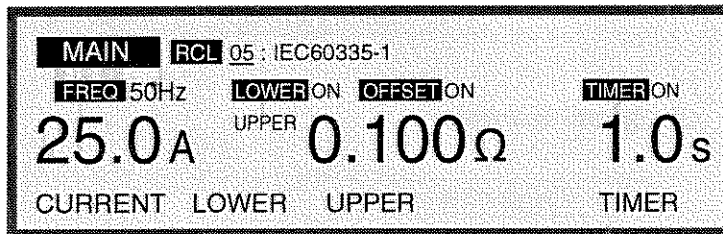

1. Press the RECALL key to display "RCL memory number: memory name" to the right of the screen title.
2. Use the rotary knob to specify the memory number to be recalled (00 to 99).
3. Press the ENTER key. This recalls the test conditions for that memory number.

Moving the cursor to another area of the screen before pressing the ENTER key aborts the recall operation. Modifying the test conditions recalled causes the memory number to disappear. It will not be redisplayed even if the original test conditions are restored.

2.8 Program

Although the total number of steps is limited to 500, a combination of test conditions stored in memory allows you to set 100 programs.

Up to 100 steps may be set as a single program. For additional information on memory, see 2.7, Panel Memory.

Press the AUTO key to turn on the AUTO key LED and display the program screen (AUTO).

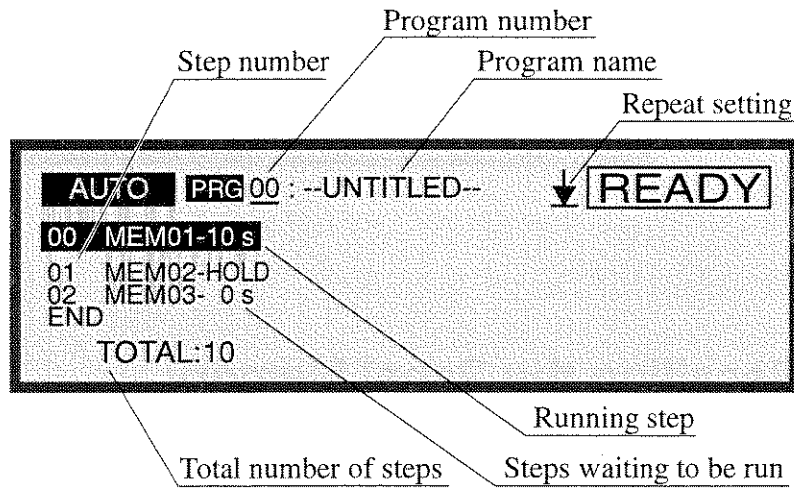

Program example:

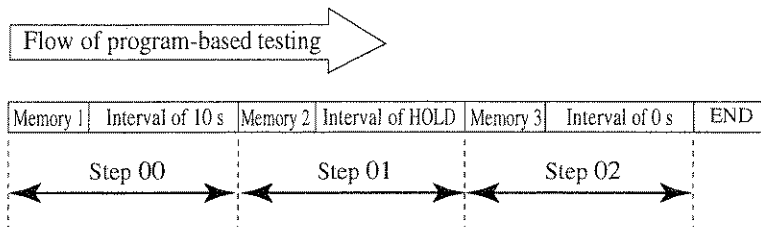

Enter the following settings to create a program like the one above:

```
00  MEM01-10s
01  MEM02-HOLD
02  MEM03-0s
END
```

Description of the program example:

The program performs a test of memory 01 in step 00 and then that of memory 02 in step 01 10 seconds after that. Because the interval time of step 01 is set to HOLD, the test of memory 3 in step 02 does not start unless you press the START switch. After the START switch is pressed and the test in step 02 is complete, the tester enters the ready status.

Replacing END at the end of the program with RET instructs the program to repeat testing from step 00.

2.8.1 Recalling the Program

Use the rotary knob to specify the program number to be recalled on the AUTO screen.

(A program number is displayed to indicate that the program has been called up.)

2.8.2 Creating or Editing the Program

Call up the number of the program you wish to create or edit in the program (AUTO) screen. Press the SHIFT + AUTO/EDIT key combination (pressing the AUTO key with the SHIFT key held down) to display the program edit screen. "EDIT" appears in the upper right portion of the LCD.

Changes are saved as soon as the program is edited or created.

The program requires that the following items be set.

- Program name
- Memory number (step setting)
- Interval time
- Repeat setting

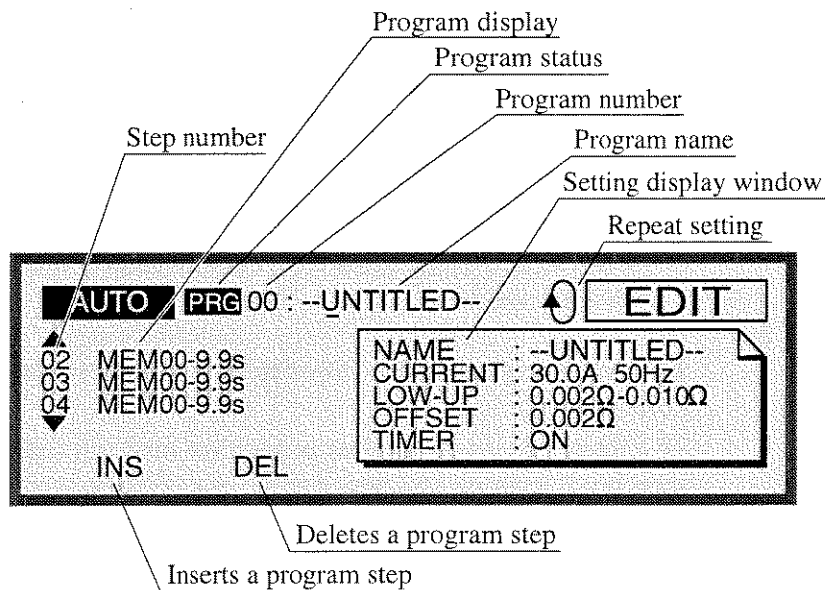

Setting a Program Name

Enter the name of a program to create (up to 12 characters) as follows:

1. Press the SHIFT + F1 key combination (pressing the F1 key with the SHIFT key held down) to move the cursor to the program name.
2. Use the ◀ ▶ keys to move the cursor to a location below the field where a character is to be entered.
3. Use the rotary knob to select the desired characters. You can enter ASCII codes 20H to 7EH as characters (see Appendix 2).

Setting a Memory Number and Interval

NOTE

- When TIMER in test conditions of the set memory number is set to OFF, the program-based testing is not completed. The step is completed by pressing the STOP switch, but the program cannot proceed to the next step.

For each step, set the memory number of the test conditions to use and the interval time up to the next step. The program will perform testing in the order of the step numbers.

Once the cursor is positioned at the step number, scroll through values with the rotary knob. You can also scroll using the ▲ ▼ keys is possible regardless of cursor position.

END or RET is displayed at the end of the steps.

1. Press the SHIFT + F1 key combination (pressing the F1 key with the SHIFT key held down) to move the cursor to the step indication.
2. Move the cursor to the step immediately below the position of a step to be inserted.
3. Press the F1 (INS) key to add the step.
(MEM00-1.0s is added to the end of the list.)
4. Press the ► key to move the cursor to MEM to the right of the step number.
5. Use the rotary knob to set a memory number.
6. Use the ► key to move the cursor to the interval time to the right of the memory number.
7. Use the rotary knob to set an interval time (0 to 9.9 s, HOLD).

When HOLD is specified for a certain interval time, pressing the START key while the specified step is in HOLD status starts the next step.

To delete a step, move the cursor to the appropriate step number and press the F2 (DEL) key.

To change a memory number or interval time for a step, move the cursor to the appropriate location and enter a new value with the rotary knob.

Repeat Setting

You can set program repeat using the SHIFT + F2 key combination (pressing the F2 key with the SHIFT key held down) regardless of cursor position.

Press the SHIFT + F2 keys toggles between END and RET.

↓ END: Ends the program; the program enters ready status at the beginning of the steps.

↻ RET: Causes the program to return to the beginning of the steps and repeat the test.

2.8.3 Running the Program

NOTE

- Releasing the START switch when start momentary is ON is equivalent to pressing the STOP switch. If a step interval has been set to HOLD in program-based automatic testing, the program cannot proceed to the next step.

Program execution is performed in the program screen (AUTO). In the program screen, the cursor cannot be moved to any item other than the program number.

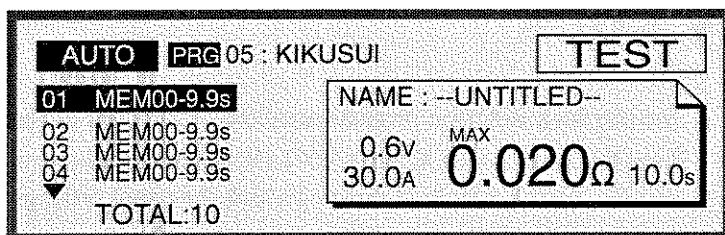

- Press the AUTO key to display the program screen (AUTO).
- Specify the number of a program to recall (run) using the rotary knob. In this case, the name of the selected program is displayed to the right of the program number.
- Press the START switch to run the program.

During the test, the tester indicates "TEST" on the LCD, and the TEST LED indicator lights up. A running step will be displayed in reverse video.

2.8.4 Suspending the Program

Press the STOP switch to halt testing during program execution.

Press the START switch again to run the program from the beginning.

2.8.5 Program PASS/FAIL Judgment

■ PASS judgment

PASS judgment is made with respect to the entire program only when the setting for program repeat is END.

At the end of the program-based test, the tester returns a PASS judgment and reverts to ready status.

■ FAIL judgment

If the tester returns a value FAIL judgment during program execution, it halts the program. Check the step where the problem occurred and press the STOP switch.

Press the START switch to run the program again from the beginning.

2.8.6 Exiting the Program

To exit the program mode and return to normal status, press the MAIN key. This turns off the LED for the AUTO key and redisplay the MAIN screen.

2.9 Key Lock

The key lock function protects accidental changing of the test conditions.

Press the SHIFT + LOCAL/KEY LOCK key combination (pressing the LOCAL key with the SHIFT key held down) to lock the panel settings.

In this case, only the START and STOP switches are available on the front panel.

When key lock is in effect, "KEY LOCK" is indicated on the LCD. To cancel key lock, press the SHIFT + LOCAL/KEY LOCK keys again.

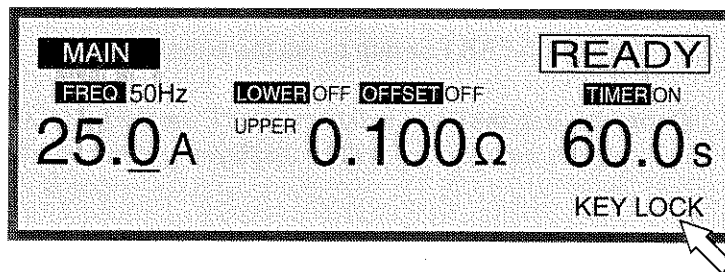

2.10 Protection

In the following cases, the TOS6200 tester activates an internal protection circuit and enters protection status.

When it enters protection status, the PROTECTION LED indicator lights and the test is halted.

■ Overheating protection

If the tester's internal temperature rises to unusual levels due to a blocked air intake or exhaust port, broken fan, use in hot conditions, or other reasons, the overheating protection function is tripped and an "OVER HEAT" indication displayed on the LCD.

Internal temperatures will fall to normal levels in approximately 10 minutes if no parts are failure. Once temperatures return to normal, press the STOP switch to cancel overheating protection.

If the overheating protection function is set off frequently, the fan or some other unit component may be failure.

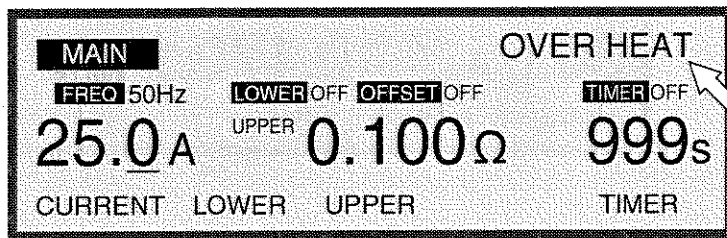

■ Test current and time

The heat radiation capacity at the output section of the tester is designed to be half the rated output by taking into account size, weight, cost, and other factors. Thus, if a test is carried out that exceeds a test current of 15 A, provide a pause time at least equal (and preferably longer) than the testing duration. The maximum testing duration is 30 minutes at ambient temperatures of 40°C or less. If the tester detects a current of 15 A or above for 30 minutes or more during testing, the "OVER HEAT" indication appears on the LCD. The noted limitation does not apply when the test current does not exceed 15 A.

Press the STOP switch to cancel overheating protection.

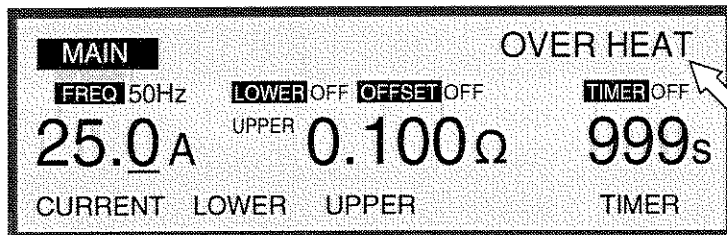
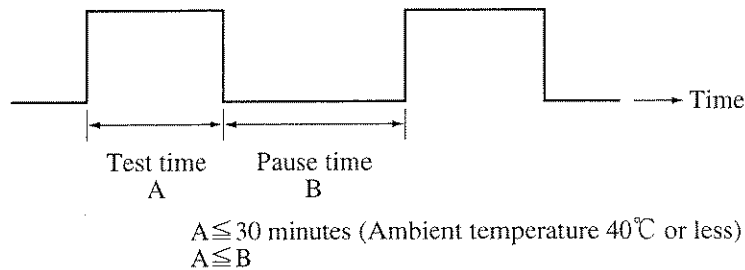

■ Overload protection

This protective function limits output power. Even for settings for which the product of the test current and upper reference value (including offset value) is 5.4 V or less and a test can be performed, the overload protection function is tripped if the output power exceeds a maximum rated output of 150 VA during testing. This causes the "OVER LOAD" indication to appear on the LCD.

For example, when the test current is 30 A, if the load resistance (including the resistance of the DUT, the test leads, and any other associated items) from the perspective of the output terminals exceeds 0.166Ω ($\cong 150/30^2$), the output power exceeds 150 VA, causing an overload. This disables testing.

Similarly, if the test current exceeds 27.7 A ($\cong 150/5.4$), an overload may occur, disabling testing.

The test current and resistance to be measured should fall within the power limitations.

Press the STOP switch to cancel overload protection.

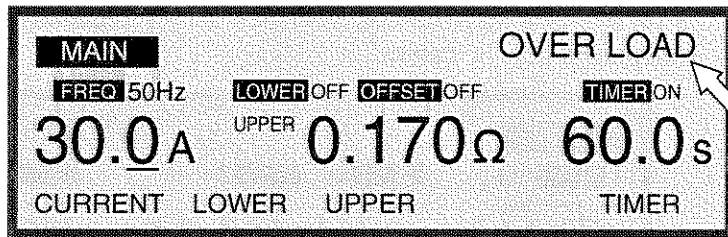

■ Output voltage limitation

This protective function limits the output voltage. If the output terminal voltage exceeds 5.6 V when the measured value is not judged FAIL during a test, the output voltage limitation function is tripped and the "VOLT LIMIT" indication is displayed on the LCD.

Since no test can be performed for settings for which the product of the test current and upper reference value (including offset value) exceeds 5.4 V, the output terminal voltage will generally not exceed 5.6 V and the output voltage limitation function is rarely tripped. However, for measurements using four terminals that use high-resistance lead wires, or for two-terminal measurements with the offset canceling function activated, the output terminal voltage may exceed 5.6 V in some cases, tripping this function. This causes the tester to enter protection status.

For example, assume that the DUT with $0.190\ \Omega$ is tested with the test current set to 25 A and upper reference value set to $0.200\ \Omega$. If the leads connected to the DUT are long and four-terminal measurements are made using leads exceeding $0.034\ \Omega$ both coming and going, the combined resistance from the perspective of the output terminals becomes $0.224\ \Omega$ or greater, tripping the output voltage limit function for 5.6 V and disabling the test.

If the product of the test current and a combined resistance from the perspective of the output terminals is closer to 5.6 V, use leads with lower resistance values.

Press the STOP switch to cancel output voltage limitation.

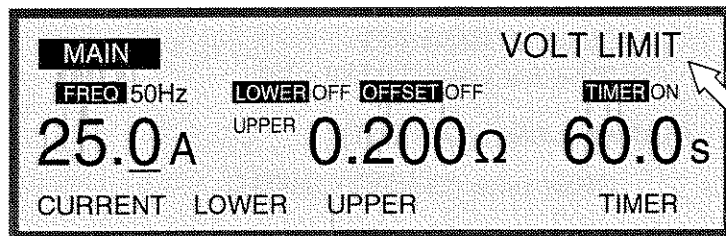

■ SIGNAL I/O signal

This indication is tripped if the level of the ENABLE signal of the SIGNAL I/O connector's pin 23 changes.

To clear this protection, press the STOP switch.

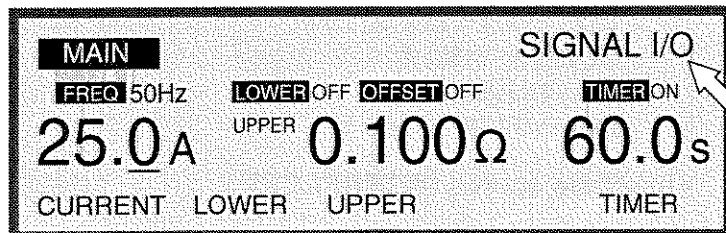

2.11 Initialize

NOTE

- Initializing clears the contents of the programs stored in memory. Before initialization, make sure that the data in memory can be erased safely.

Settings corresponding to the various safety standards are stored in memory addresses 1 to 18. For information on these settings, see Appendix 4, Initial Settings of the Memory.

To initialize, press the POWER switch with the SHIFT key held when starting the tester. This restores tester settings to factory-set values. (Press the SHIFT key until the characters "KIKUSUI ELECTRONICS CORP." disappear.)

■ Factory-shipped settings

• Test conditions set up screen (MAIN)

Test current (CURRENT): 3.0 A
Frequency (FREQ): 50 Hz
Lower limit judgment (LOWER): OFF
Lower reference value (LOWER): 0.001 Ω
Upper reference value (UPPER): 0.100 Ω
Offset (OFFSET): OFF
Timer (TIMER): OFF
Timer set value (TIMER): 1.0 s

• Offset screen (OFFSET)

Offset value (OFFSET): 0.000 Ω

• System screen (SYSTEM)

MEAS MOD: NORM
PASS HOLD: 0.2s
REMOTE SEL: 1
MOMENTARY: OFF
FAIL MODE: OFF
DOUBLE ACTION: OFF
CONTACT CHECK: OFF
BUZZER VOL: 4
CONTRAST: 6
COMMENT: cleared

• Interface screen (INTERFACE)

GPIB ADDRESS: 3
SPEED: 19200
DATA: 8
PARITY: NONE
STOP: 2

The TOS6200 tester lets you to connect optional peripherals to the REMOTE terminal on the front panel or input a signal through the SIGNAL I/O connector on the rear panel to control start and stop of a test. The SIGNAL I/O connector also lets you check the tester's status based on its output signal.

3.1 REMOTE Terminal

The REMOTE terminal is a 5-pin DIN connector located on the front panel.

This connector is used to connect the optional RC01-TOS or RC02-TOS remote control boxes or the LTP-2 test probe.

When you connect an option, the START and STOP switches on the option and those on the front panel are both available.

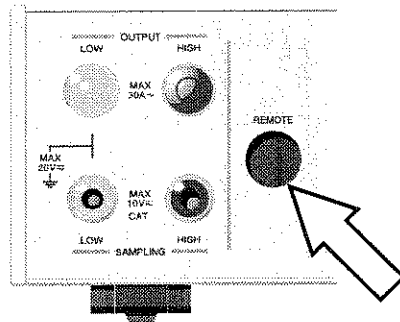

Fig. 3-1 REMOTE Terminal

3.2 SIGNAL I/O Connector

-
- WARNING** • To avoid electric shocks, always turn off the power supply of the related equipment when connecting or disconnecting a cable from the SIGNAL I/O connector.
-

The SIGNAL I/O connector is a D-SUB 25-pin connector located on the rear panel used to control testing start and stop or to monitor the status of the tester.

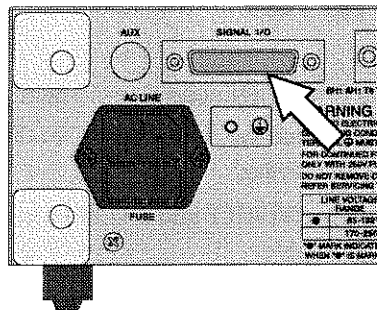

Fig. 3-2 SIGNAL I/O Connector

Connector on the tester side

Omron Corp. XM2B-2502 D-SUB 25-pin female connector

Connection cable

D-SUB 25-pin male to D-SUB 25-pin male, straight cable

Connector compatible with connection cable

Omron Corp. XM2D-2501 D-SUB 25-pin female connector or equivalent

-
- NOTE** • To avoid malfunctions caused by noise, use a shielded D-SUB 25-pin connector and cable less than 3 m in length.
-

3.2.1 SIGNAL I/O Connector Specifications

■ Input signal

Active-low control input

High-level input voltage: 11 to 15 V

Low-level input voltage: 0 to 4 V

Low-level input current: -5 mA maximum

Input time width: 5 ms minimum

■ Output signal

Open collector output

Output withstand voltage: 30 V DC

Output saturation voltage: Approximately 1.1 V (at 25°C)

Maximum output current: 400 mA (total)

■ Pin configuration

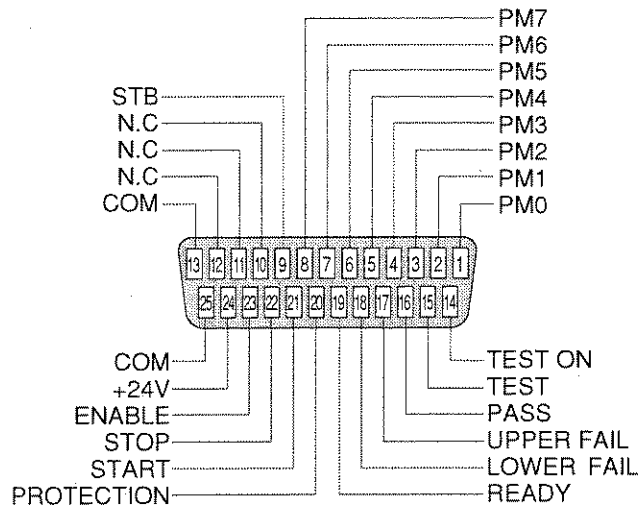

Fig. 3-3 SIGNAL I/O Pin Configuration

-
- ⚠ CAUTION** • To avoid damage to internal circuits, take care to avoid short circuiting +24 V at pin 24 to the chassis or circuit common.
-

No.	Signal name	I/O	Description of signal	
1	PM0	I	LSB	2-digit BCD active-low input Panel memory or program select signal input terminal. This select signal is latched at the rise of a strobe signal to recall the panel memory or program.
2	PM1	I	LSD	
3	PM2	I		
4	PM3	I		
5	PM4	I		
6	PM5	I		
7	PM6	I		
8	PM7	I	MSB	
9	STB	I	Panel memory or program strobe signal input terminal.	
10	N.C			
11	N.C			
12	N.C			
13	COM		Circuit common	
14	TEST ON	O	ON during testing.	
15	TEST	O	ON during test (not including the period of a current/voltage rise).	
16	PASS	O	ON for approximately 0.2 s or more when a measured value is judged PASS. It is continuously ON when PASS HOLD is set to ON.	
17	UPPER FAIL	O	Continuously ON if a measured value is the upper reference value or greater and judged FAIL.	
18	LOWER FAIL	O	Continuously ON if a measured value is the lower reference value or less and judged FAIL.	
19	READY	O	ON while the tester is in ready status.	
20	PROTECTION	O	ON if PROTECTION status arises.	
21	START	I	Start signal input terminal.	
22	STOP	I	Stop signal input terminal.	
23	ENABLE	I	Start signal's ENABLE signal input terminal	
24	+24V	O	+24 V internal power output terminal. Maximum output current is 100 mA.	
25	COM		Circuit common	

Table 3-1 SIGNAL I/O Pin Configuration

Internal configuration

The input and output signal circuits share the same common.

Because the input signal circuit is pulled up to +12 V, opening the input terminals is equivalent to inputting a high-level signal.

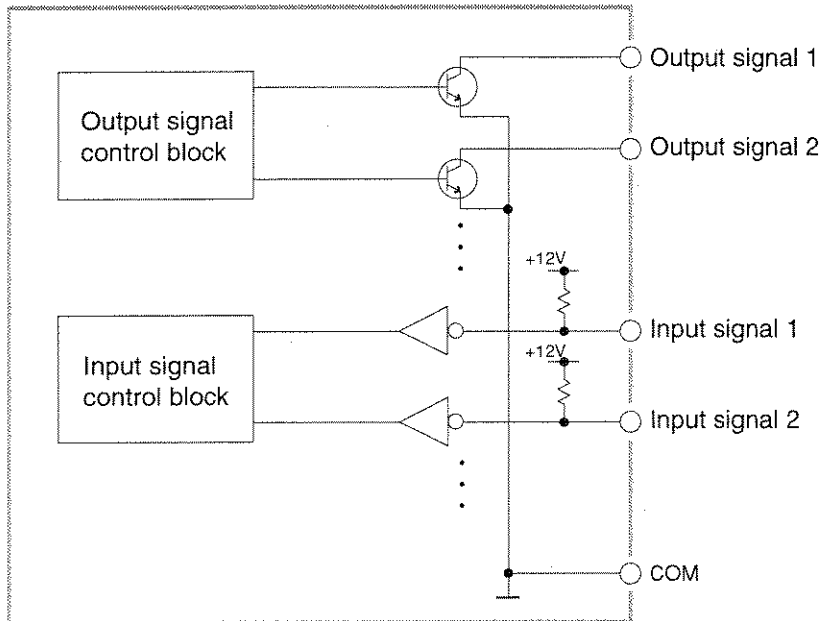

Fig. 3-4 Internal Configuration of the SIGNAL I/O Connector

3.2.2 Starting a Test

An ENABLE signal should be set LOW and then a START signal set LOW.

In this case, a START signal of the SIGNAL I/O connector and a START signal via the REMOTE terminal are available and the START switch on the front panel is void.

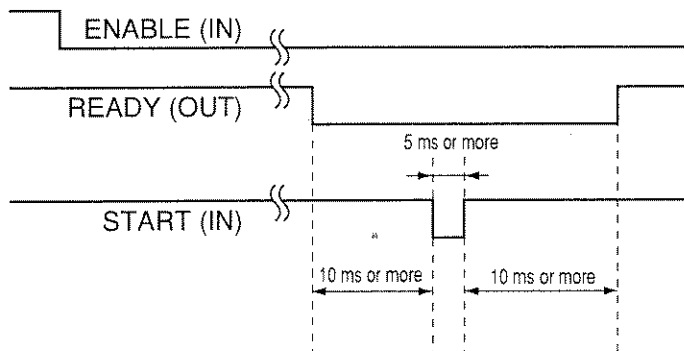

Fig. 3-5 START Signal

3.2.3 Recalling a Panel Memory and Program

Ready status, PM, and STB signals are handled according to the following timing.
(Be sure that a READY signal set LOW.)

Table 3-2 gives the relation of PM0 to PM7 signals to the panel memory number or program number to be recalled:

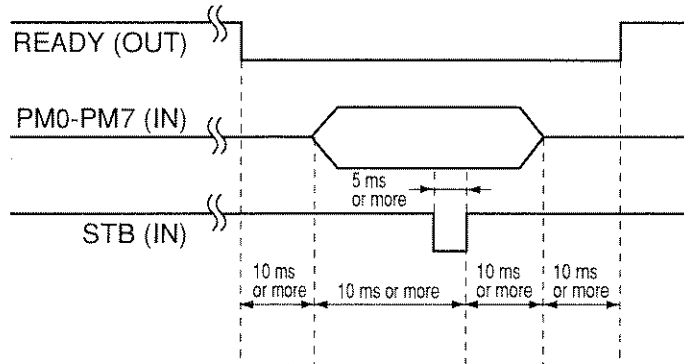

Fig. 3-6 Strobe Signal

MSD				LSD				MAIN	AUTO
PM7	PM6	PM5	PM4	PM3	PM2	PM1	PM0		
H	H	H	H	H	H	H	H	Recalls panel memory 0	Recalls program 0
H	H	H	H	H	H	H	L	Recalls panel memory 1	Recalls program 1
H	H	H	H	H	H	L	H	Recalls panel memory 2	Recalls program 2
.
L	H	H	L	L	H	H	H	Recalls panel memory 98	Recalls program 98
L	H	H	L	L	H	H	L	Recalls panel memory 99	Recalls program 99

Table 3-2 PM Signals and Panel Memory or Program Number to be Recalled

3.2.4 Examples of Use

■ Input signal

Example of control with a make contact

This example makes the input terminal level Low using a make contact such as a relay, switch, or another element.

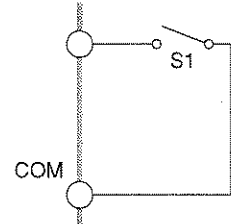

Example of control with logic element

This example uses a logic element such as transistors instead of a switch in the above example.

Consider drawing a transistor collector current i_c of 5 mA or greater.

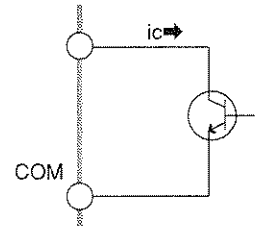

■ Output signal

Example of driving a relay

This example drives a relay with an output signal.

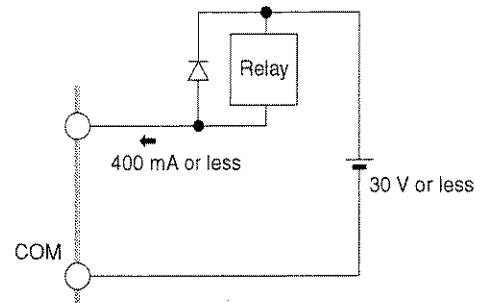

Example of getting the "L" level of digital signal

This example obtains the "L" level of digital signal with respect to an output signal.

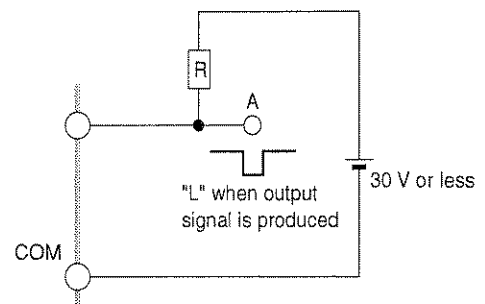

This chapter describes the device messages used to create a program for remote control of the tester via GPIB or RS-232C.



- To avoid electric shock, always turn off the power supply of the related equipment when connecting or disconnect a cable from the interface connector.

4.1 Interface

This tester is provided with two interfaces: GPIB and RS-232C. If the tester is to be remotely controlled, one of them must be used.

4.1.1 GPIB Interface

To use the GPIB interface, set a GPIB address on the tester. To set a GPIB address, see 2.6, "Interface setup."

GPIB cables are available from Kikusui. Contact Kikusui distributor/agent.

GPIB cable 1 m (code: 92080)

GPIB cable 2 m (code: 92070)

GPIB cable 4 m (code: 92090)

4.1.2 RS-232C Interface

To use the RS-232C interface, make the following settings:

For settings, see 2.6, "Interface setup."

RS-232C interface communications rate

RS-232C interface data length

RS-232C interface parity

RS-232C interface stop bit

Control communication via RS-232C using flow control or acknowledgment messages. One-way transmission may make proper communication difficult. For acknowledgment messages, see 4.2.1, "Messages."

For an RS-232C interface cable, use a D-sub 9-pin female-female AT cross type.

RS-232C pin layout

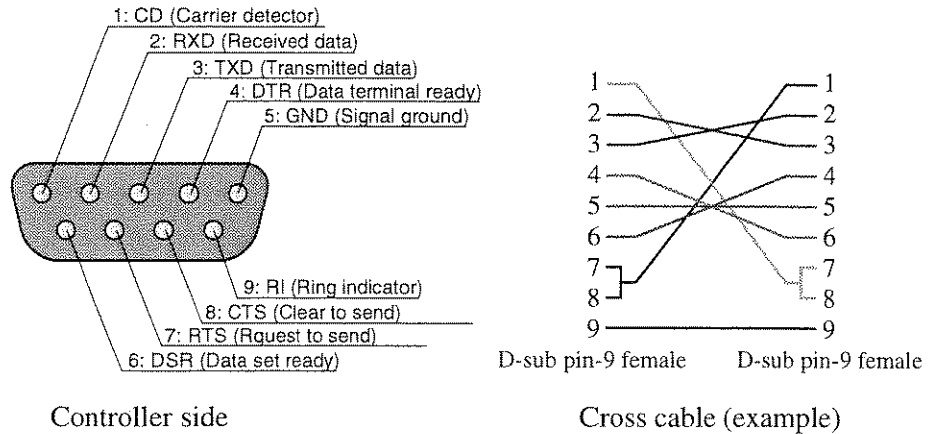

Fig. 4-1 Pin-9 AT-type connector

RS-232C flow control

By executing Xon/Xoff, communication among the tester can be controlled. For control, DC (device control) codes are used.

	Function	ASCII code
DC1	Request transmission	11 h
DC3	Request termination of transmission	13 h

Control of transmission from the RS-232C terminal to the tester

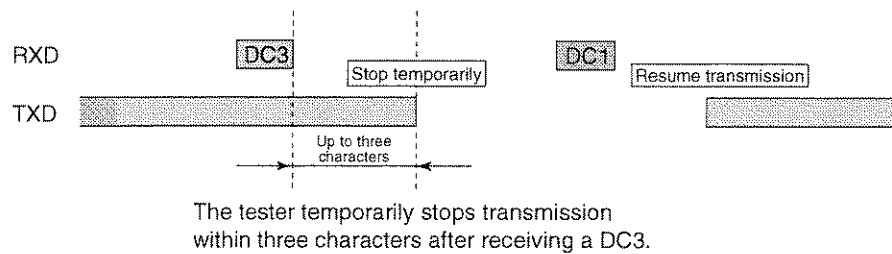

Control of transmission from the tester to the RS-232C terminal

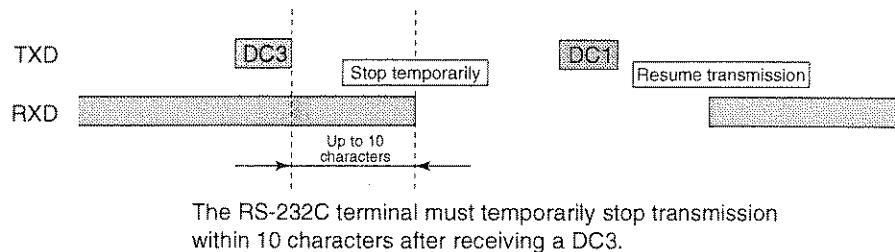

Fig. 4-2 Control of transmission between the RS-232C terminal and the tester

4.2 Message and Terminator

This section provides terminology and details concerning communication between the personal computer (controller) and the tester (devices). See Fig. 4-3.

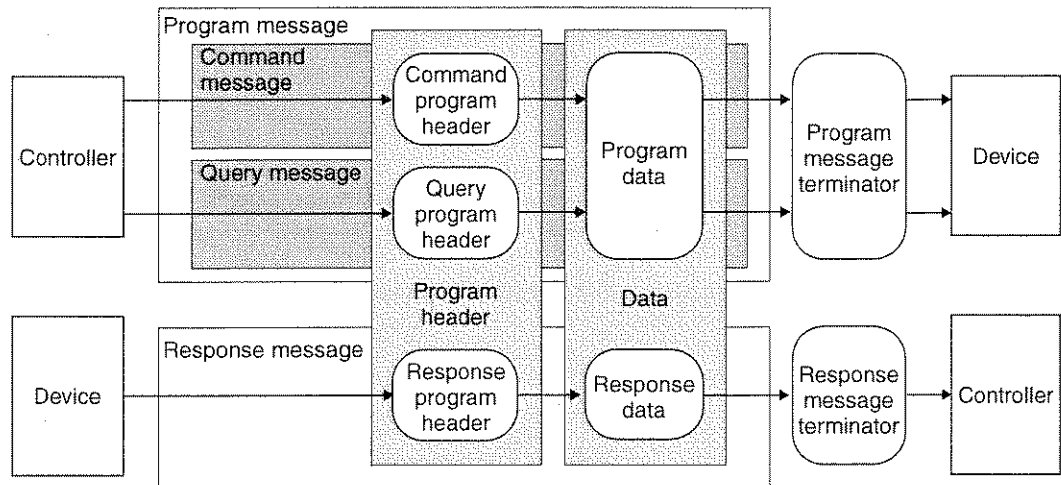

Fig. 4-3 Messages and terminators

4.2.1 Messages

In this manual, commands sent from a computer to the tester are called program messages, while responses sent from the tester to the computer are called response messages.

Each message consists of a program header and data sections.

Program messages

There are two types of program messages: command messages and query messages. A command message is used to execute a specified function of a device and to alter settings.

A query message is used to inquire about the settings and status of a device.

4.2.2 Terminator

The terminator used to indicate that a program message has been terminated is called a “program message terminator.” The terminator used to indicate that a response message has been terminated is called a “response message terminator.”

- **Program message terminators**

One of the following may be used. No preliminary settings are required.

- LF
- LF+EOI
- EOI
- CR+EOI

- **Response message terminators**

CR+LF+EOI is set by default. Using a TRM command message, it can be changed to one of the following:

- CR+LF+EOI
- LF+EOI
- EOI
- CR+EOI

4.3 Device Messages

The program messages and response messages supported by the TOS6200 are referred to as device messages.

This section describes each device message supported by the tester. An item enclosed within parentheses beside a device message name is the abbreviation of that device message.

4.3.1 Register-Related and General-Purpose Messages

The following describes the device messages used to set, clear, or inquire about each register and general-purpose device messages used to specify of a terminator and other items.

***CLS** (Command message only)

Clears of the status byte register, event status register, device status register, protection register, fail register, invalid setting register and error register.

For details on each register, see 4.4, "Registers."

■ Command message



***ESR?** (Query message only)

Returns the value of the event status register, then clears it.

For details on the event status register, see 4.4, "Registers."

■ Query message

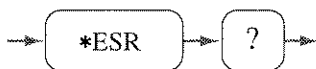

■ Response message

Returns the contents of the event status register to *ESR?.

Example: If Bit 5 of the event status register is set,

"32" is returned.

***IDN?** (Query message only)

Inquiries about the model name and ROM version of the tester.

■ Query message



■ Response message

Returns the model name of the tester to *IDN in the following manner:

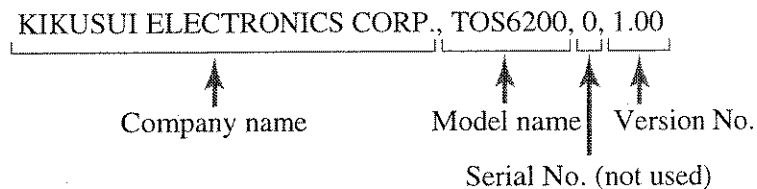

***RST** (Command message only)

Initializes the tester (to original factory-set settings). Note that settings in the INTERFACE screen will not be initialized.

For details on initializes, see 2.11, "Initializes."

■ Command message



*SRE

Used to set or reset each bit of the service request enable register.
Also used to inquire about the contents of the service request enable register.
For details on the service request enable register, see 4.4, “Registers.”

■ Program message

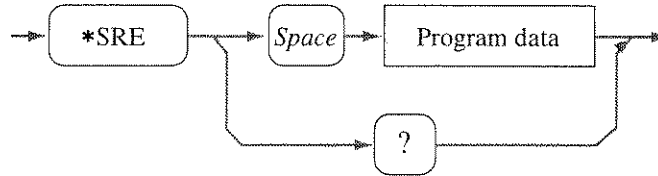

■ Program data

Setting/resetting of the service request enable register	
Minimum value	0
Maximum value	255
Resolution	1
Data format	Hexadecimal or decimal numbers
Initial value	70H

Example: *SRE#H01

■ Response message

Returns the contents of the service request enable register to *SRE?.

Example: If Bit 5 of the service request enable register is set,
“32” is returned.

***STB?** (Query message only)

Used to inquire about the contents of the status byte register.
For details on the status byte register, see 4.4, "Registers."

■ Query message



■ Response message

Returns the contents of the status byte register to *STB?.
Example: If Bit 4 of the status byte register is set,
"16" is returned.

CLR (Command message only)

Clears the all registers exclusive of enable register and sets STOP flag.
The same processing is performed as when the GPIB bus line message DCL or SDC has been received. Also used to perform the same processing as is performed by a DCL message from the RS-232C.

■ Command message

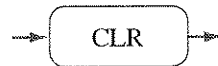

DSE

Used to set or reset each bit of the device status enable register.

Also used to inquire about the contents of the device status enable register.

For details on the device status enable register, see 4.4, "Registers."

■ Program message

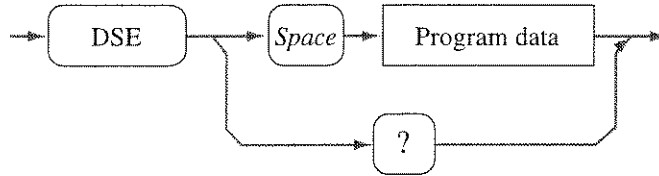

■ Program data

Setting/resetting of the device status enable register	
Minimum value	0
Maximum value	255
Resolution	1
Data format	Hexadecimal or decimal numbers
Initial value	80H

Example: DSE #H01

■ Response message

Returns the contents of the device status enable register to DSE?.

Example: If Bit 5 of the device status enable register is set,

"32" is returned.

DSR? (Query message only)

Used to inquire about the contents of the device status register.
For details on the device status register, see 4.4, "Registers."

■ Query message



■ Response message

Returns the current test status in response to DSR?.

1: Ready, 2: Inv Set, 4: Test, 8: Test on,
16: Pass, 32: Fail, 64: Stop, 128: Protection

Example 1: When the current status is ready

A value of 1 is returned.

Example 2: When a test is being made

A value of 12 is returned. (4:Test + 8:Test on)

Example 3: When contact check is ON

A value of 8 is returned.

ERR? (Query message only)

Used to inquire about the contents of the error register.
For details on the error register, see 4.4, "Registers."

■ Query message

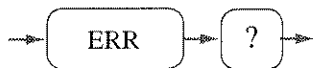

■ Response message

Returns the contents of the error register to ERR?.

Example: If Bit 1 of the error register is set,

"2" is returned.

FAIL? (Query message only)

Used to inquire about the contents of the fail register.
For details on the fail register, see 4.4, "Registers."

■ Query message



■ Response message

Returns the contents of the fail register to FAIL?.
Example: If Bit 2 (UPPER FAIL) of the fail register is set,
"4" is returned.

INVALID? (INV?) (Query message only)

Used to inquire about the contents of the invalid setting register.
For details on the invalid setting register, see 4.4, "Registers."

■ Query message

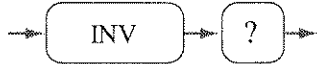

■ Response message

Returns the contents of the invalid setting register to INV?.
Example: If Bit 0 (OVER VOLT) of the invalid setting register is set,
"1" is returned.

PROTECTION? (PROT?) (Query message only)

Used to inquire about the contents of the protection register.
For details on the protection register, see 4.4, "Registers."

■ Query message

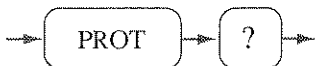

■ Response message

Returns the contents of the protection register to PROT?.
Example: If Bit 2 (OVER LOAD) of the protection register is set,
"4" is returned.

SILENT (SIL)

Used in control via RS-232C to specify whether to return an acknowledgment message to a message divided by the response message terminator. The SILENT? message is used to inquire about the set value that specifies whether to return an acknowledgment message.

As an acknowledgment message, either "OK" or "ERROR" is returned.

If an acknowledgment message is to be received, the RS-232C must be set at full duplex communication.

Full duplex communication: The transmission of data in two directions simultaneously. For full duplex settings, see the manual for your PC.

■ Program message

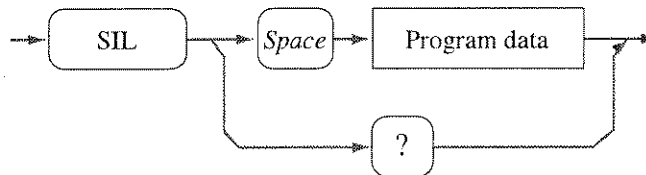

■ Program data

Switching an acknowledgement message	
Minimum value	0
Maximum value	1
Resolution	1
Data format	Integer 0: Return an acknowledgement message. 1: Do not return an acknowledgement message.
Initial value	1

■ Response message

The set value for the SILENT message is returned to SIL?.

Example: If settings are made so that an acknowledgment message will not be returned,
the message "1" is returned.

TRM

Used to set the response message terminator, then inquire about the set value it. Note that the GPIB uni-line message "EOI" is effective only in GPIB communication.

■ Program message

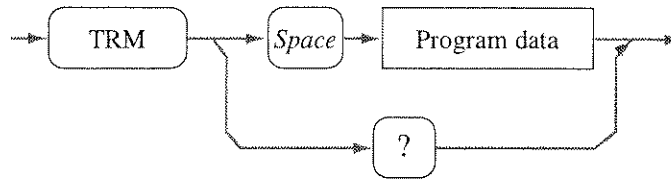

■ Program data

Setting the response message terminator	
Minimum value	0
Maximum value	3
Resolution	1
Data format	Integer 0: CR/LF + EOI 1: LF + EOI 2: EOI 3: CR + EOI
Initial value	0

■ Response message

The response message terminator currently set is returned to TRM?.

Example: If the response message terminator is set at LF+EOI, the message "1" is returned.

4.3.2 System-Related Messages

This subsection explains the device messages for items to be set on the tester SYSTEM screen.

BUZZERVOL (BVOL)

Sets or inquires about the buzzer volume.

■ Program message

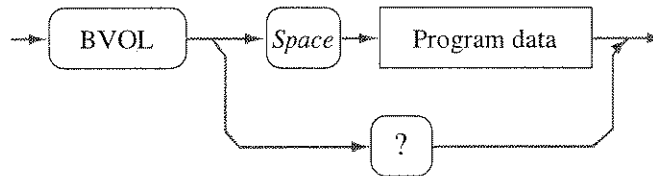

■ Program data

Setting of the buzzer volume	
Minimum value	1
Maximum value	10
Resolution	1
Data format	Integer

Example: VOL 2

■ Response message

Returns the buzzer set volume in response to BVOL?.

Example: When the volume is set to 3

A value of 3 is returned.

COMMENT (COM)

Inputs comments or inquires about its contents.

■ Program message

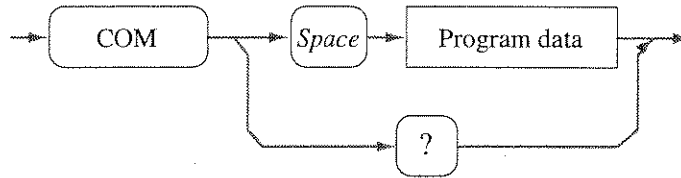

■ Program data

Inputs comments		
Parameter	Maximum characters	Input characters
1st line	20	ASCII Code 20H to 7EH *1
2nd line	20	ASCII Code 20H to 7EH *1
3rd line	20	ASCII Code 20H to 7EH *1
Data format	Character	

*1: 22H "", 27H "", 2CH ",", and 40H "@" may not be used (see Appendix 2).

Example: COM "KIKUSUI","TOS6200","!#\$%&()*+"

■ Response message

Returns the contents of the comments in response to a COM?.

This fills blank entries with spaces so that each line has 20 characters, then returns this as the result.

Example: If "KIKUSUI" is entered in the 1st line, no data is entered in the 2nd line, and "123456789ABCDEFGHIJK" is in the 3rd line, the response message returns the following result: (_ = space)

KIKUSUI_____,_____,123456789ABCDEFGHIJK

CONTACTCHECK (CCH)

Sets the contact check function to ON/OFF, or inquires about its ON/OFF status.

■ Program message

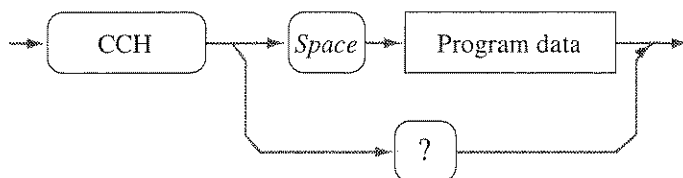

■ Program data

ON/OFF of the contact check function	
Data format	Character
Character program data	0 or OFF, 1 or ON

■ Response message

Returns the ON/OFF status of the contact check function in response to a CCH?.

Example: When the contact check function is ON

A value of 1 is returned.

CONTRAST (CON)

Sets the contrast or inquires about the value set for contrast.

■ Program message

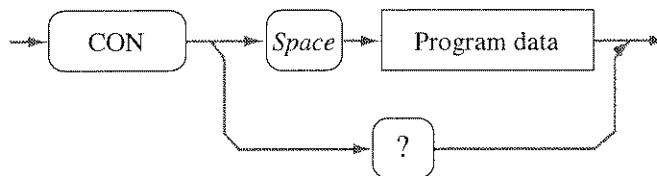

■ Program data

Setting of the contrast	
Minimum value	0
Maximum value	10
Resolution	1
Data format	Integer

Example: CON 5

■ Response message

Returns the set value of contrast in response to a CON?.

Example: When contrast is set to 3

A value of 3 is returned.

DOUBLEACTION (DAC)

Sets ON/OFF for start double action or inquires about ON/OFF status.

■ Program message

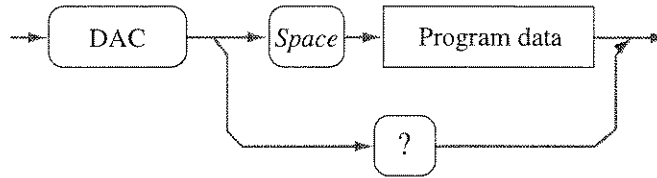

■ Program data

ON/OFF of the start double action	
Data format	Character
Character program data	0 or OFF, 1 or ON

Example: DAC 0

■ Response message

Returns the set value of start double action in response to a DAC?.

Example: When the start double action has been set to ON

A value of 1 is returned.

FAILMODE (FMOD)

Sets ON/OFF for the fail mode or inquires about ON/OFF status.

■ Program message

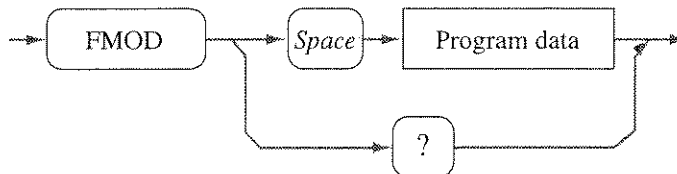

■ Program data

ON/OFF of the fail mode	
Data format	Character
Character program data	0 or OFF, 1 or ON

■ Response message

Returns the ON/OFF status of the fail mode in response to a FMOD?.

Example: When fail mode is ON

A value of 1 is returned.

MEASMODE (MMOD)

Sets or inquires about resistance measurement mode.

■ Program message

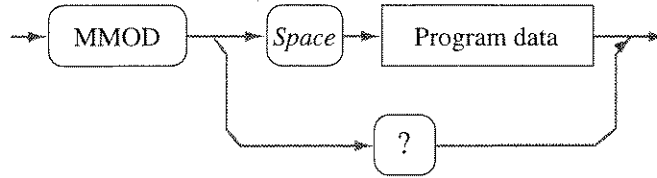

■ Program data

Setting of the resistance measurement mode	
Data format	Character
Character program data	NORM: Normal measurement mode
	MAX: Measurement mode that holds the maximum value

NORM: NORMAL

■ Response message

Returns the measurement mode for resistance in response to a MMOD?.

Example: When the measurement mode for resistance is NORM

A value of NORM is returned.

MOMENTARY (MOM)

Sets ON/OFF for start momentary or inquires about ON/OFF status.

NOTE

- Releasing the START switch when start momentary is ON is equivalent to pressing the STOP switch. If the interval of a step has been set to HOLD in a program-based automatic test, the program cannot proceed to the next step.

■ Program message

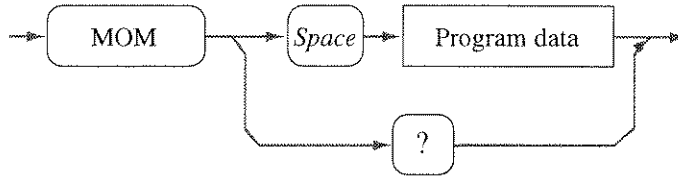

■ Program data

ON/OFF of the start momentary	
Data format	Character
Character program data	0 or OFF, 1 or ON

■ Response message

Returns the ON/OFF status of the start momentary in response to a MOM?.

Example: When start momentary is ON

A value of 1 is returned.

PASSHOLD (PHOL)

Sets the PASS hold time or inquires about the value set for PASS hold time.

■ Program message

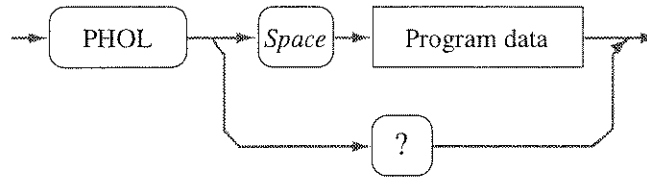

■ Program data

Setting of the PASS hold time	
Minimum value	0.2
Maximum value	10.0, HOLD
Resolution	0.1
Unit of suffix	s
Data format	Integer, Character
Character program data	HOLD

■ Response message

Returns the set value of PASS hold time in response to a PHOL?.

Example 1: When the PASS hold time has been set to 2 seconds

A value of 2.0 is returned.

Example 2: When the PASS hold time has been set to HOLD

A value of HOLD is returned.

4.3.3 Messages Relating to Test Conditions and Test Execution

This subsection describes device messages associated with test condition settings and testing start/stop.

CURRENT (CUR)

Sets the test current of the tester or inquires about its set value.

NOTE

- The current value may be changed, even when a test is under way. However, do not make significant changes exceeding several amperes.

Do not modify the test current if the resistance value is close to the upper reference value, as doing so may result in a FAIL judgment.

- The test current setting range for the tester is within 3 A to 30 A AC when the resistance value is such that the output power is less than the maximum rated output and the output terminal voltage is 5.4 V or less. Thus, for settings for which the product of the test current value and upper reference value (including offset value, when the OFFSET is ON) exceeds 5.4 V, the tester turns off the READY indication and blinks the OVER VOLT indication instead. This informs the operator that the test cannot be carried out.

Moreover, the power limitation safety function is tripped if the output power exceeds the maximum rated output of 150 VA during testing, causing the tester to enter protection status.

Use test current and upper reference values within this range.

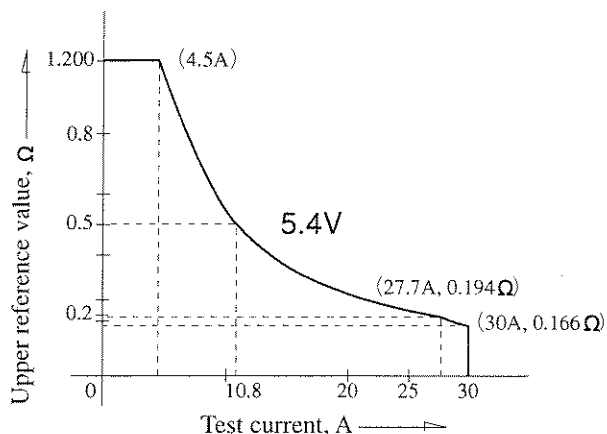

■ Program message

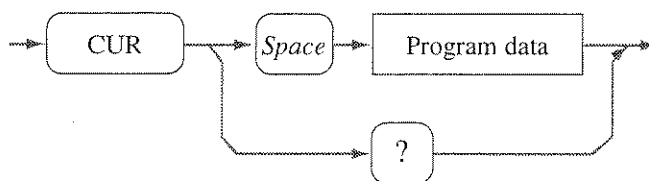

■ Program data

Setting of output current	
Minimum value	3.0
Maximum value	30.0
Resolution	0.1
Unit of suffix	A
Data format	Real

■ Response message

Returns the set value of test current in response to a CUR?.

Example: When the set test current is 10.0 A

A value of 10.0 is returned.

FREQUENCY (FREQ)

Sets the test frequency or inquires about its set value.

■ Program message

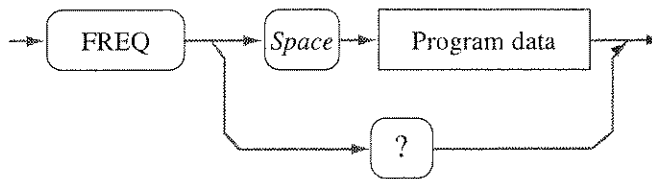

■ Program data

Setting of test frequency	
Unit of suffix	Hz
Data format	Character
Character program data	50, 60

■ Response message

Returns the set value of test frequency in response to a FREQ?.

Example: When the test frequency is 50 Hz

A value of 50 is returned.

LOWER (LOW)

Sets the lower reference value and ON/OFF for the lower limit judgement function or inquires about the ON/OFF status.

NOTE

- If a lower reference value higher than the upper reference value is set while lower limit judgment is ON, the "READY" indication goes out and the "UP<=LOW" indication appears and blinks to inform the operator that the test cannot be performed.

In this case, lower the lower reference value or raise the upper reference value.

■ Program message

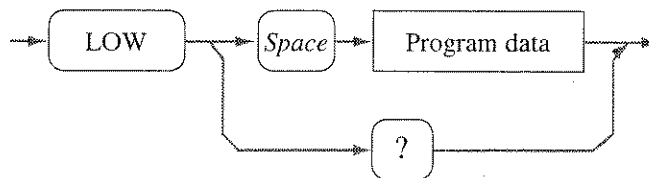

■ Program data

Setting of the lower reference value and ON/OFF of the lower reference judgment	
Minimum value	0.001
Maximum value	1.200
Resolution	0.001
Unit of suffix	OHM
Data format	Integer, Character
Character program data	0 or OFF, 1 or ON

Sets the lower reference value, followed by an ON/OFF for the lower limit judgement function.

Example: When setting the lower reference value to 0.5 Ω and setting the lower limit judgment function to ON

LOW 0.5,1

■ Response message

Returns the lower reference value and ON/OFF status for the lower limit judgement function in response to a LOW?.

Example: When the lower reference value is 0.500 Ω and the lower limit judgement is OFF

A value of 0.500,0 is returned.

UPPER (UPP)

Sets the upper reference value of the tester or inquires about its set value.

NOTE

- If a lower reference value higher than the upper reference value is set while lower limit judgment is ON, the "READY" indication goes out and the "UP<=LOW" indication appears and blinks to inform the operator that the test cannot be performed. (The lower reference value is factory-set to 0.100 Ω .)

In this case, lower the lower reference value or raise the upper reference value.

- The test current setting range for the tester is within 3 A to 30 A AC when the resistance value is such that the output power is less than the maximum rated output and the output terminal voltage is 5.4 V or less. Thus, for settings for which the product of the test current value and upper reference value (including offset value, when the OFFSET is ON) exceeds 5.4 V, the tester turns off the READY indication and blinks the OVER VOLT indication instead. This informs the operator that the test cannot be carried out.

Moreover, the power limitation safety function is tripped if the output power exceeds the maximum rated output of 150 VA during testing, causing the tester to enter protection status (OVER LOAD).

Use test current and upper reference values within this range.

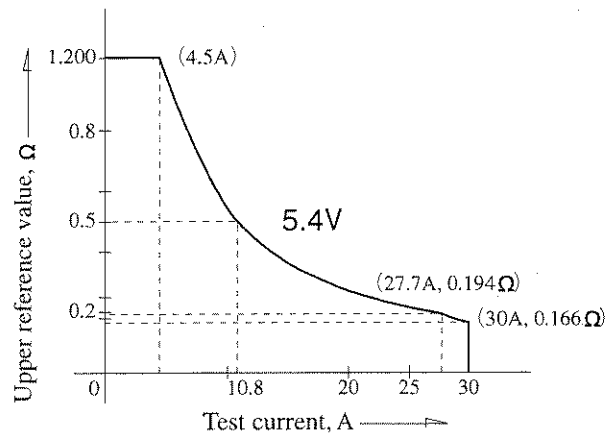

■ Program message

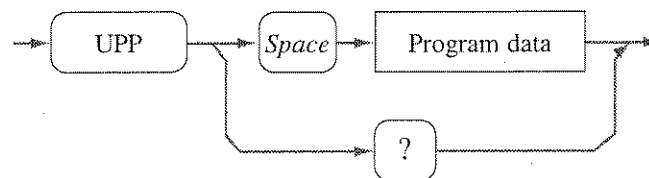

■ Program data

Setting of the upper reference value	
Minimum value	0.001
Maximum value	1.200
Resolution	0.001
Unit of suffix	OHM
Data format	Real

■ Response message

Returns the set value of upper reference value in response to a UPP?.

Example: When the upper reference value is 0.100 Ω

A value of 0.100 is returned.

OFFSET (OFF)

Sets ON/OFF for offset cancel function or inquires about ON/OFF status.

■ Program message

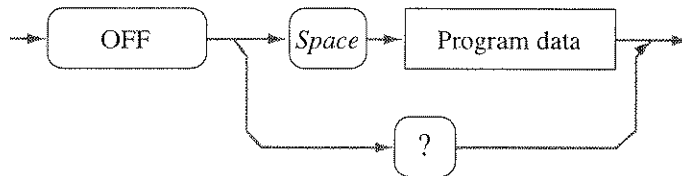

■ Program data

ON/OFF of the offset cancel function	
Data format	Character
Character program data	0 or OFF, 1 or ON

■ Response message

Returns the ON/OFF status of the offset cancel function in response to a OFF?.

Example: When offset cancel function is ON

A value of 1 is returned.

TIMER (TIM)

Sets or inquires about the duration set with the timer and the timer ON/OFF setting.

■ Program message

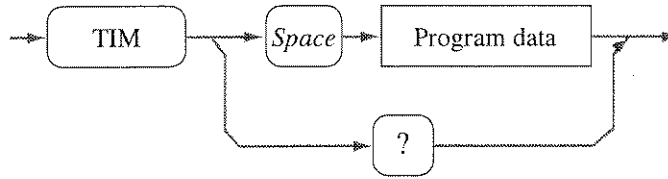

■ Program data

Setting of the timer				
Parameter	Minimum value	Maximum value	Resolution	Unit
Test time	0.3	999	0.3 to 99.9 : 0.1 100 to 999 : 1	s
Timer function	0 or OFF, 1 or ON			
Data format	Integer, Character			

Sets the test time, followed by ON/OFF for the timer function

Even when the timer function is set to OFF, you must enter a test time.

In this case, enter any value (Example: maximum value).

Example: TIM 999,0

■ Response message

Returns the test time and ON/OFF status for the timer function in response to a TIM?.

Example: When the test time is 60 s and the timer function is ON

A value of 60.0,1 is returned.

START (STAR) (Command message only)

Starts testing.

While a test program is running, it shifts the program from the step suspended due to a HOLD setting in the interval to the next step.

This command message is valid only in the test conditions set up (MAIN), offset measurement (OFFSET), or program (AUTO) screens. Switch screens using the FUNCTION message..

■ Command message



STOP (Command message only)

Stops a test or cancels fail, pass (hold) and protection status.

■ Command message



4.3.4 Messages Relating to the Tester Status

This subsection describes device messages used to check the status of the tester or measured values.

FUNCTION (FUN)

Shifts the LCD to each mode (setting screen) or inquires about the current mode (displayed screen).

■ Program message

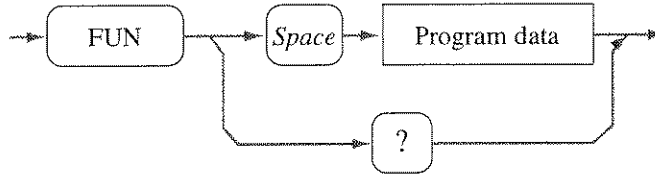

■ Program data

Shift of the mode	
Minimum value	0
Maximum value	4
Resolution	1
Data format	Integer 0: Test conditions setup screen (MAIN) 1: Program screen (AUTO) 2: Program edit screen (AUTO EDIT) 3: System setup screen (SYSTEM1) 4: Offset screen (OFFSET)

■ Response message

Returns the current mode (displayed screen) in response to a FUN?.

Example: When the current mode (displayed screen) is any figure other than 0 to 4

A value of 5 is returned.

IDATA? (IDAT?) (Query message only)

Inquires about the present measured current value.

■ Query message



■ Response message

Returns the present measured current value in response to a IDAT?

It returns the current value being measured during a test or the measured current value obtained immediately before when the test was completed.

Example: When the present measured current value is 25.0 A

A value of 25.0 is returned.

MON? (Query message only)

Inquires for the tester's test status.

Values of device status register:

Measured voltage value (0 to 6.00 V)

Measured current value (0 to 35.0 A)

Maximum measured resistance value (0 to 9.999 Ω)

Normal measured resistance value (0 to 9.999 Ω)

Elapsed time (0.3 to 99.9 s / 100 to 999 s) or Remaining time (0.0 to 99.9 s / 100 to 999 s)

Those test statuses may be inquired about separately.

Device status register: DSR?

Measured voltage value: VDATA?

Measured current value: IDATA?

Measured resistance value (maximum or normal): RDATA?

Elapsed or remaining time: TIME?

■ Query message

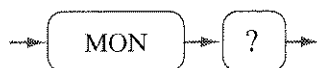

■ Response message

Returns the test status of the tester in response to a MON?

Example: When the device status register: TEST and TEST ON (bit 2, 3 are 1), measured voltage value: 4.50 V, measured current value: 25.0 A, maximum measured resistance value: 0.182 Ω , measured resistance value: 0.180 Ω , and elapsed time: 5.0 s

A value of 12,4.50,25.0,0.182,0.180,5.0 is returned.

RDATA? (RDAT?)(Query message only)

Inquires for the present measured resistance value.

■ Query message



■ Response message

Returns the present measured resistance value in response to a RDATA?

It returns the resistance value measured during a test, or the measured resistance value obtained immediately before when the test has been completed.

Example: When the present measured resistance value is 0.003 Ω

A value of 0.003 is returned.

DSR? (Query message only)

Used to inquire about the contents of the status byte register.

(Inquires about the current status of the tester.)

For details on the status byte register, see 4.4, "Registers."

■ Query message



■ Response message

Returns the current test status in response to DSR?.

1: Ready, 2: Inv Set, 4: Test, 8: Test on,
16: Pass, 32: Fail, 64: Stop, 128: Protection

e.g.1: When the current status is ready

A value of 1 is returned.

e.g.2: When a test is being made

A value of 12 is returned. (4:Test + 8:Test on)

e.g.3: When contact check is ON

A value of 8 is returned.

TIME? (Query message only)

Inquires about the elapsed or remaining time of a test.

■ Query message



■ Response message

Returns the elapsed or remaining time of the test in response to a TIME?

Example: When the timer function is ON and the remaining time is 10 seconds
A value of 10 is returned.

VDATA? (VDAT?) (Query message only)

Inquires for the present measured voltage value.

■ Query message



■ Response message

Returns the present measured voltage value in response to a VDAT?

It returns the voltage value measured during a test, or the measured voltage value obtained immediately before when the test has been completed.

Example: When the present measured voltage value is 3.50 V
A value of 3.50 is returned.

4.3.5 Memory-Related Messages

This subsection describes device messages associated with memory for test conditions and their storage in memory.

On shipment from the factory, settings corresponding to various safety standards are written to memory numbers 1 to 18. For information on these settings, see Appendix 4, Initial Settings of the Memory.

MEMORY (MEM)

Sets, changes, or inquires about memory contents.

■ Command message

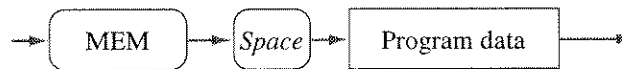

■ Program data

Change of the memory contents				
Parameter	Minimum value	Maximum value	Resolution	Unit
Memory number	0	99	1	
Memory name *1	20H	7EH		
Test current value	3.0	30.0	0.1	A
Upper reference value	0.001	1.200	0.001	OHM
Lower reference value	0.001	1.200	0.001	OHM
Sets the test time	0.3	999	0.1 or 1	s
Sets the test frequency	50	60	50/60	Hz
ON/OFF of the lower reference judgment	0, OFF	1, ON	0/1	
ON/OFF of the offset	0, OFF	1, ON	0/1	
ON/OFF of the timer	0, OFF	1, ON	0/1	
Data format	Integer, Character			

*1: 22H "", 27H "", 2CH ",", and 40H "@" may not be used (see Appendix 2).

NOTE

- All parameters must be entered, even when the lower limit judgement is set to OFF. (Enter any value into the lower reference value field the minimum value, for example.)

Example: To set memory name TEST1, test current 10 A, upper reference value 0.100 Ω, lower reference value 0.001 Ω, timer 0.3 s, frequency 50 Hz, lower limit judgment OFF, offset OFF, and timer OFF to memory number 01:

MEM 01,"TEST1",10.0,0.100,0.001,0.3,50,0,0,0

■ Response message

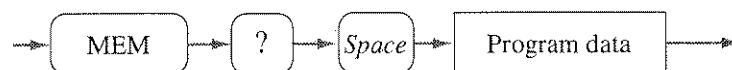

Returns memory contents relative to the memory number in MEM?

Example: When memory contents 10 is memory name TEST1, test current 30.0 A, upper reference value 1.200 Ω , lower reference value 0.001 Ω , timer 999 s, frequency 50 Hz, lower limit judgment ON, offset ON, and timer ON in "MEM? 10"

A value of the TEST1,30.0,1.200,0.001,999,50,1,1,1 is returned.

RECALL (REC) (Command message only)

Recalls memory contents.

■ Command message

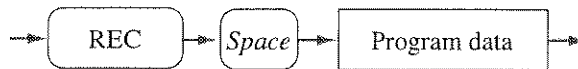

■ Program data

Recall memory	
Minimum value	0
Maximum value	99
Resolution	1
Data format	Integer

Example: REC 5

STORE (STOR) (Command message only)

Saves the present test conditions to memory. Note that the memory name is not stored.

(A memory name at the storage destination will be retained.)

■ Command message

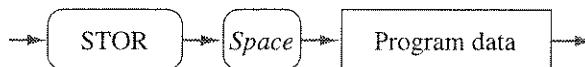

■ Program data

Saves the test conditions	
Minimum value	0
Maximum value	99
Resolution	1
Data format	Integer

Example: STOR 5

4.3.6 Program-Related Messages

This subsection explains device messages associated with items set in the program screen (AUTO).

PRGDEL(PDEL) (Command message only)

Deletes a program step.

This device message is the equivalent to the F2 (DEL) key on the program edit screen.

■ Command message

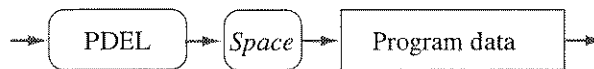

■ Program data

Deletes a program step			
Parameter	Minimum value	Maximum value	Resolution
Program number	0	99	1
Program step number	0	99	1
Data format	Integer		

Example: To delete step 10 in program number 1:

PDEL 1,10

PRGEDIT(PED)

Sets a program on a step basis or inquires about the contents of the program.

■ Command message

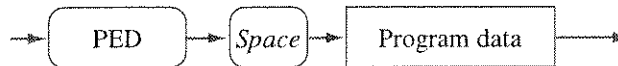

■ Program data

Sets, Changes the contents of the program				
Parameter	Minimum value	Maximum value	Resolution	Unit
Program number	0	99	1	
Program step number	0	99	1	
Memory number	0	99	1	
Sets the interval time	0	9.9, HOLD	0.1	s
Data format	Real, Character			

NOTE

- All parameters must be entered. Enter even values that do not need to be changed.
- You cannot skip numbers while setting step numbers. You must either overwrite a currently set step with a new step or add it to the end of a list of steps.
- Sending a PRGEDIT (PED) command while the AUTO TEST screen is displayed automatically brings up the AUTO EDIT screen.
- Up to 500 steps can be allotted to a program. For example, if 100 steps each are allotted to programs 0 to 4, no steps can be allotted to program 5.

Example: To assign memory number 5 to step 10 in program number 1 and set the interval time to HOLD:

PED 1,10,5,HOLD

■ Response message

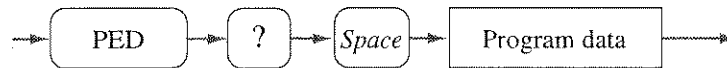

Returns the contents of the step corresponding to the program number and step number in PED?.

Example: When "PED? 5,1" inquires about the contents of step 1 in program 5 and step 1 is configured as memory 11 and an interval time of 5 seconds

A value of the 11,5 is returned.

PRGINS(PIN)

(Command message only)

Inserts a step in a test program and sets a memory number for the program. During step insertion, the interval time is set to 1.0 s.

■ Command message

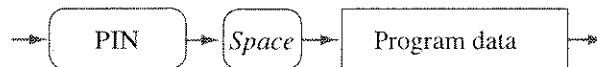

■ Program data

Inserts a step and sets a memory number			
Parameter	Minimum value	Maximum value	Resolution
Program number	0	99	1
Program step number	0	99	1
Memory number	0	99	1
Data format	Integer		

NOTE

- You cannot skip numbers while setting step numbers. You must either overwrite a currently set step with a new step or add it to the end of a list of steps.
- Up to 500 steps can be allotted to a program. For example, if 100 steps each are allotted to programs 0 to 4, no steps can be allotted to program 5.

Example: To assign memory number 5 to step 10 in program number 1
PIN 1,10,5

PRGNAME(PNAM)

Assigns a name to a program (up to 12 characters), or inquires about the program name.

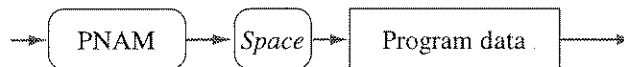
■ Command message**■ Program data**

Assigns a name to a program name			
Parameter	Minimum value	Maximum value	Resolution
Program number	0	99	1
Program name *1	20H	7EH	
Data format	Integer, Character		

*1: 22H "", 27H "", 2CH ",", and 40H "@" may not be used (see Appendix 2).

Example: To assign a name of TEST1 to program number 1
PNAM 1,"TEST1"

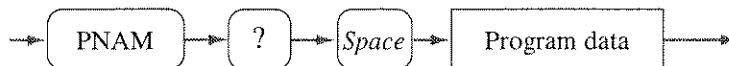
■ Response message

Returns the name of the program corresponding to the program number in PNAM?

Example: When program 1 named TEST1 is inquired about with a "PNAM? 1"
A value of the TEST1 is returned.

PRGNEW (PNEW)

(Command message only)

Clears the contents of the program corresponding to a program number.

■ Command message

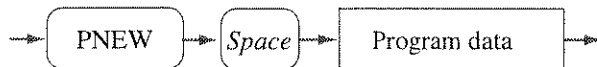

■ Program data

Clears the contents of the program	
Minimum value	0
Maximum value	99
Resolution	1
Data format	Integer

Example: To clear the contents of program 5

PNEW 5

PRGRETURN (PRET)

Sets ON/OFF for the RET at the end of program steps, or inquires about the RET ON/OFF status. (If RET is set to OFF, END is assigned to the end of the program.)

■ Command message

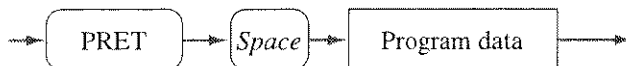

■ Program data

ON/OFF for RET at the end of the program			
Parameter	minimum value	maximum value	Resolution
Program number	0	99	1
ON/OFF of RET	0 or OFF, 1 or ON		
Data format	Integer, Character		

Specify the program number followed by ON/OFF.

Example: PRET 5,1

■ Response message

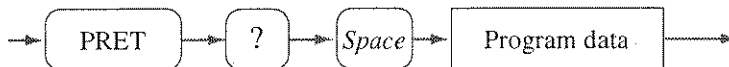

Returns the ON/OFF setting for RET of the program corresponding to the program number in PRET?.

Example: When program 5 with RET set to ON is inquired about by a "PRET? 5"

A value of the 1 is returned.

PRGTEST (PTES) (Command message only)

Recalls program contents.

■ Command message

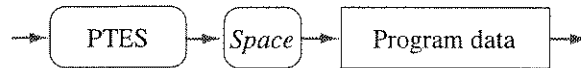

■ Program data

Recalls program	
Minimum value	0
Maximum value	99
Resolution	1
Data format	Integer

PRGTOTAL?(PTOT?) (Query message only)

Inquires about the number of steps corresponding to a program number.

■ Query message



■ Program data

Inquires the number of steps	
Minimum value	0
Maximum value	99
Resolution	1
Data format	Integer

■ Response message

Returns the number of steps in the program corresponding to the program number in PTOT?.

Example: When a program 1 with 50 steps is inquired about with a "PTOT? 1"

A value of the 50 is returned.

The total number of steps for programs is limited to 500. To check the total number of steps, get the number of steps for each program with a PTOT? and sum the numbers of steps.

4.4 Registers

The following shows the structure of status data:

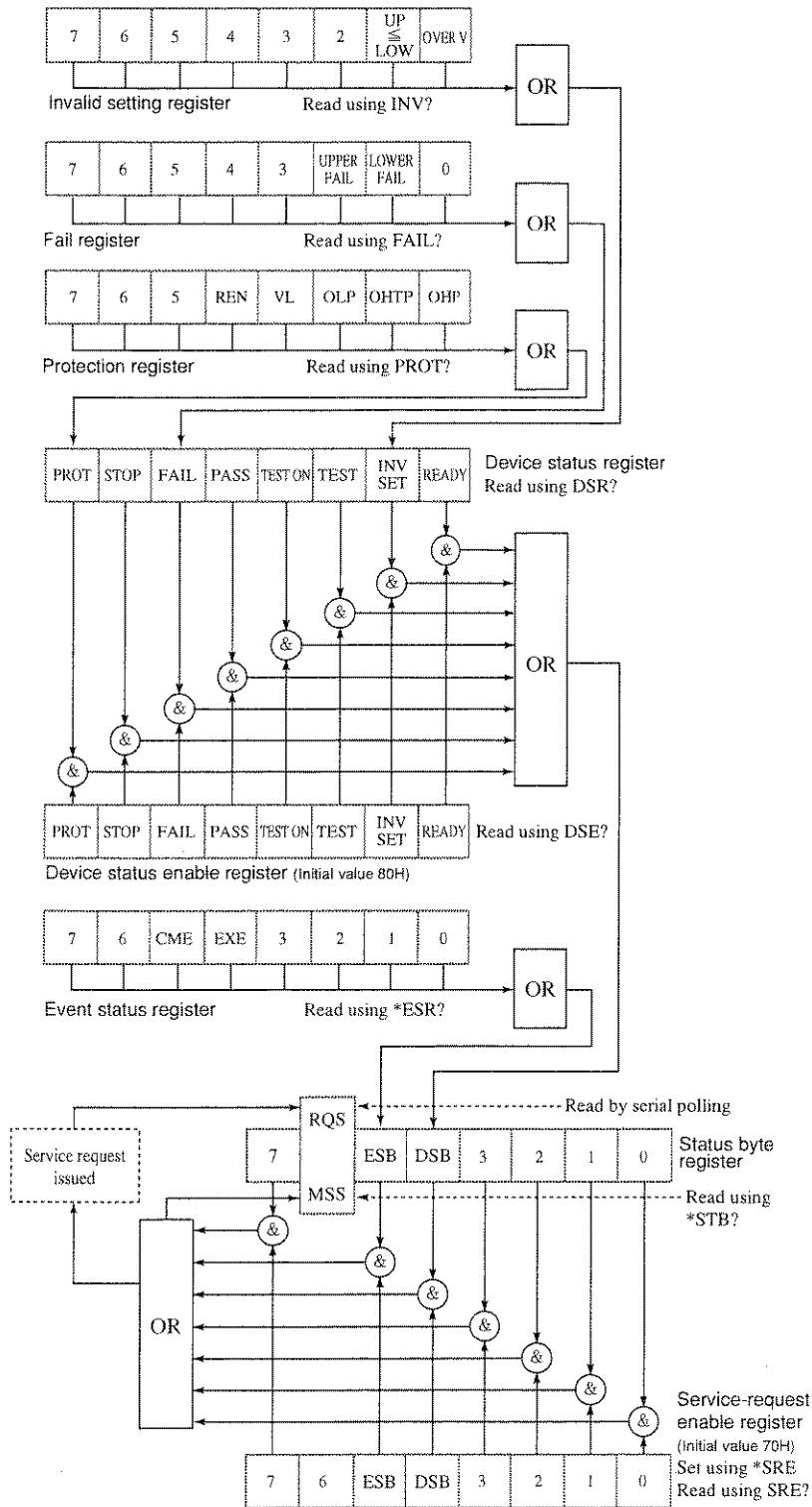

Fig. 4-4 Structure of status data

NOTE

- Each bit of each register indicates that it is set when it is 1 and reset when 0.
- The contents of the enable register are not backed up.

Status Byte Register, Service Request Enable Register

Bit		Description
7		Not used in the tester
6	RQS (Request)	Indicates that a service request has been issued. Reset when read using a serial poll.
	MSS (Master Summary Status)	ORed result of the status byte register and service request enable register, which is ready by running *STB.
5	ESB (Standard Event Status Bit)	Indicates that a bit of the event status register has been set.
4	DSB (Device Status Bit)	Indicates that a bit of the device status register has been set.
3		Not used in the tester
2		Not used in the tester
1		Not used in the tester
0		Not used in the tester

Table 4-1 Status Byte Register, Service Request Enable Register

Event Status Register

Bit		Description
7		Not used in the tester
6		Not used in the tester
5	CME (Command Error)	Indicates that a syntax, data, or out-of-range error has occurred.
4	EXE (Execution Error)	Indicates that an invalid device message has been received during testing or while in protection status.
3		Not used in the tester
2		Not used in the tester
1		Not used in the tester
0		Not used in the tester

Table 4-2 Event Status Register

Device Status Register, Device Status Enable Register

Bit	Description
7	PROT (Protection)
6	STOP
5	FAIL
4	PASS
3	TEST ON
2	TEST
1	INV SET (Invalid setting)
0	READY

Table 4-3 Device Status Register, Device Status Enable Register

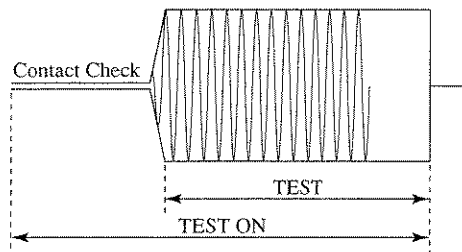

Fig. 4-5 Relation of TEST (Bit 2) to TEST ON (Bit 3)

Protection Register

Bit	Description
7	Not used in the tester
6	Not used in the tester
5	Not used in the tester
4	REN (Remote Enable)
3	VL (Voltage Limit)
2	OLP (Over Load Protection)
1	OHTP (Over Heat Timer Protection)
0	OHP (Over Heat Protection)

Table 4-4 Protection Register

Fail Register

Bit	Description
7	Not used in the tester
6	Not used in the tester
5	Not used in the tester
4	Not used in the tester
3	Not used in the tester
2	UPPER FAIL Indicates that the result has been judged as FAIL, exceeding the upper reference limit.
1	LOWER FAIL Indicates that the result has been judged as FAIL, exceeding the lower reference limit.
0	Not used in the tester

Table 4-5 Fail Register

Invalid Setting Register

Bit	Description
7	Not used in the tester
6	Not used in the tester
5	Not used in the tester
4	Not used in the tester
3	Not used in the tester
2	Not used in the tester
1	$UP \leq LOW$ Indicates that the set value for lower limit judgement exceeds the upper reference value.
0	OVER V (Over Voltage) Indicates that the test voltage has exceeded 5.4 V.

Table 4-6 Invalid Setting Register

Error Register

Bit	Description
7	Not used in the tester
6	Not used in the tester
5	Not used in the tester
4	Not used in the tester
3	Invalid device message Indicates that an invalid device message was generated.
2	Out-of-range error Indicates occurrence of out-of-range error.
1	Data error Indicates occurrence of data error.
0	Syntax error Indicates occurrence of header error.

Table 4-7 Error Register

4.5 List of Device Messages

	Header	Data				Function and response data	1	2
		Minimum value	Maximum value	Resolution	Unit			
1	*CLS					Clears the status byte register, event status register, device status register, protection register, fail register, invalid setting register, and error register.	○	○
2	*ESR?					Returns the value of the event status register, then clears it.	○	○
3	*IDN?					Returns the tester model name and ROM version.	○	○
4	*RST					Initializes the tester (to factory-shipped settings. Note that interface settings are not initialized.)	○	○
5	*SRE	0	255			Setting for the service request enable register	×	×
6	*SRE?					Returns the value of the service request enable register.	○	○
7	*STB?					Returns the value of the status byte register.	○	○
8	BUZZERVOL (BVOL)	1	10	1		Setting for the buzzer volume	×	×
9	BUZZERVOL? (BVOL?)					Returns the value set for the buzzer volume.	○	○
10	CLR					Clears the input buffer and has it wait for a device message. Equivalent to DCL and SDC.	○	○
11	COMMENT (COM)	20H	7EH			1st comment (memo) line, 20 characters *1	×	×
		20H	7EH			2nd comment (memo) line, 20 characters *1		
		20H	7EH			3rd comment (memo) line, 20 characters *1 (*1: ":", ":", ":", and "@" cannot be used in comments.)		
12	COMMENT?					Returns the comment (memo) contents. (In form of "1st comment line", "2nd comment line", "3rd comment line")	○	○
13	CONTACTCHECK (CCH)	0, OFF	1, ON			Setting for contact check. (Test starts when a load is connected.)	×	×
14	CONTACTCHECK? (CCH?)					Returns the ON/OFF status for the contact check. (0 or 1)	○	○
15	CONTRAST (CON)	0	10	1		Setting for contrast.	×	×
16	CONTRAST? (CON?)					Returns the value set for contrast.	○	○
17	CURRENT (CUR)	3.0	30.0	0.1	A	Setting for test current	○	×
18	CURRENT? (CUR?)					Returns the value set for test current.	○	○
19	DOUBLEACTION (DAC)	0, OFF	1, ON			Setting for start double action.	×	×
20	DOUBLEACTION? (DAC?)					Returns the ON/OFF status for start double action. (0 or 1)	○	○
21	DSE	0	255			Setting for device status enable register.	×	×
22	DSE?					Returns the value of the device status enable register.	○	○
23	DSR?					Returns the value of the device status register.	○	○
24	ERR?					Returns the value of the error register.	○	○
25	FAIL?					Returns the value of the fail register.	○	○
26	FAILMODE (FMOD)	0, OFF	1, ON			Setting for fail mode. (To clear a FAIL or PROTECTION condition, press the STOP switch.)	×	×
27	FAILMODE? (FMOD?)					Returns the ON/OFF status for fail mode. (0 or 1)	○	○

	Header	Data				Function and response data	1	2
		Minimum value	Maximum value	Resolution	Unit			
28	FREQUENCY (FREQ)	50	60		Hz	Setting for test frequency	×	×
29	FREQUENCY? (FREQ?)					Returns the value set for test frequency.	○	○
30	FUNCTION (FUN)	0	4	1		Mode switching 0: MAIN 1: AUTO TEST 2: AUTO EDIT 3: SYSTEM 4: OFFSET ADJ	×	×
31	FUNCTION? (FUN?)					Returns the current mode (displayed screen). 1: AUTO TEST 2: AUTO EDIT 3: SYSTEM 4: OFFSET ADJ 5: Others	○	○
32	IDATA? (IDAT?)					Returns a measured current value (0 to 35.0).	○	○
33	INVALID? (INV?)					Returns the value of the invalid setting register.	○	○
34	LOWER (LOW)	0.001	1.200	0.001	OHM	Setting for the lower reference value.	×	×
		0, OFF	1, ON			ON/OFF setting for the lower limit judgment function.		
35	LOWER? (LOW?)					Returns the value set for the lower reference value.	○	○
						Returns the ON/OFF status for the lower limit judgment function. (0 or 1)		
36	MEASMODE (MMOD)	NORM	MAX			Setting for the resistance measurement mode. NORM: Normal measurement mode MAX: Measurement mode that retains the peak value	×	×
						Returns the setting status of the measured result indication.		
37	MEASMODE? (MMOD?)						○	○
38	MEMORY (MEM)	0	99	1		Memory number	×	×
		20H	7EH			Memory name (maximum of 12 characters; " ", " ", " ", and "@" cannot be used.)		
		3.0	30.0	0.1	A	Current value		
		0.001	1.200	0.001	OHM	Upper reference value		
		0.001	1.200	0.001	OHM	Lower reference value		
		0.3	999	0.1, 1	s	Test time		
		50	60		Hz	Frequency		
		0, OFF	1, ON			ON/OFF for the lower reference value		
		0, OFF	1, ON			ON/OFF for the offset function		
0, OFF	1, ON			ON/OFF for the timer function				
39	MEMORY? (MEM?)	0	99	1		Reads the contents of a corresponding memory.	○	○
						Returns the memory name (12 characters).		
						Returns the current value (3.0 to 30.0 A).		
						Returns the upper reference value (0.001 to 1.200 Ω).		
						Returns the lower reference value (0.001 to 1.200 Ω).		
						Returns the test time (0.3 to 999 s).		
						Returns the frequency set value (50/60 Hz).		
						Returns the ON/OFF status for the lower limit judgment function (0/1).		
				Returns the ON/OFF status for the offset function (0/1).				
				Returns the ON/OFF status for the timer function (0/1).				

	Header	Data				Function and response data	1	2
		Minimum value	Maximum value	Resolution	Unit			
40	MOMENTARY (MOM)	0, OFF	1, ON			Setting for the start momentary function.	×	×
41	MOMENTARY? (MOM?)					Returns the ON/OFF status for the start momentary function (0/1).	○	○
42	MON?					Returns the value of the device status register. (Same as DSR?)	○	○
						Returns a measured voltage value (0 to 6.00 V).		
						Returns a measured current value (0 to 35.0 A).		
						Returns the peak value of the measured resistance (0 to 9.999 Ω).		
						Returns the normal value of the measured resistance (0 to 9.999 Ω).		
	Returns elapsed (or remaining) time (0.3 to 99.9 / 100 to 999 s)							
43	OFFSET (OFF)	0, OFF	1, ON			ON/OFF for the offset function	×	×
44	OFFSET? (OFF?)					Returns the ON/OFF status for the offset function (0 or 1).	○	○
45	PASSHOLD (PHOL)	0.2	10, HOLD	0.1	s	Setting for PASS holding time	×	×
46	PASSHOLD? (PHOL?)					Returns the value set for PASS holding time.	○	○
47	PRGDEL (PDEL)	0	99	1		Program number	×	×
		0	99	1		Program step number		
48	PRGEDIT (PED)	0	99	1		Program number	×	×
		0	99	1		Program step number		
		0	99	1		Memory number		
		0	9.9, HOLD	0.1	s	Interval time up to the next step		
49	PRGEDIT? (PED?)	0	99	1		Program number	○	○
		0	99	1		Program step number		
						Returns the contents of the step corresponding to the step number in program number.		
50	PRGINS (PIN)	0	99	1		Program number	○	○
		0	99	1		Program step number		
		0	99	1		Memory number		
51	PRGNAME (PNAM)	0	99	1		Program number	×	×
		20H	7EH			Setting for program name (maximum of 12 characters; " ", " ", " ", and "@" cannot be used.)		
52	PRGNAME? (PNAM?)	0	99	1		Returns the program name corresponding to the program number.	○	○
53	PRGNEW (PNEW)	0	99	1		Clears the program corresponding to the program number.	×	×
54	PRGRETURN (PRET)	0	99	1		Program number	×	×
		0, OFF	1, ON			Setting for program repeat OFF, 0: END (ends program) ON, 1: RET (repeats program)		
55	PRGRETURN? (PRET?)	0	99	1		Returns the setting status for program repeat corresponding to the program number.	○	○
						Program repeat 0: END (ends program) 1: RET (repeats program)		
56	PRGTEST (PTES)	0	99	1		Recalls a program.	×	×
57	PRGTOTAL? (PTOT?)	0	99	1		Returns the number of steps in the program corresponding to the program number.	○	○
58	PROTECTION? (PROT?)					Returns the value of the protection register.	○	○

	Header	Data				Function and response data	1	2
		Minimum value	Maximum value	Resolution	Unit			
59	RDATA? (RDAT?)					Returns a measured resistance value (0 to 9.999 Ω).	○	○
60	RECALL (REC)	0	99	1		Recalls memory contents.	×	×
61	SILENT (SIL)	0	1			Switching of acknowledge message during RS-232C communications	×	×
62	SILENT? (SIL?)					Returns the value specified by SILENT.	○	○
63	START (STAR)					Starts a test.	×	×
65	STOP					Stops a test.	○	○
66	STORE (STOR)	0	99	1		Saves the current test conditions to memory. (Note that the memory name is not changed)	×	×
67	TIME?					Returns the test time (0.3 to 999 s). * Returns the elapsed time when TIMER is set to OFF. Returns the time remaining when TIMER is set to ON.	○	○
68	TIMER (TIM)	0.3 0, OFF	999 1, ON	*1	s	Timer set value (*1: 0.1 for 0.3 to 99.9 or 1 for 100 to 999) ON/OFF for the timer function	×	×
69	TIMER? (TIM?)					Returns the value set for timer function (0.3 to 99.9 / 100 to 999) Returns the ON/OFF status for the timer function (0 or 1).	○	○
70	TRM	0	3	1		Setting for response message terminator 0: CR/LF+EOI, 1: LF+EOI, 2: EOI, 3: CR+EOI	×	×
71	TRM?					Returns a current response message terminator.	○	○
72	UPPER (UPP)	0.001	1.200	0.001	OHM	Setting for upper reference value	×	×
73	UPPER? (UPP?)					Returns the upper reference value (0.001 to 1.200 Ω).	○	○
74	VDATA? (VDAT?)					Returns a measured voltage value (0 to 6.00 V).	○	○

Note: About 1 and 2 at the right end of the List of Device Messages

- 1 : Device messages available even during testing are indicated by an ○; those not available are indicated by an ×.
- 2 : Device messages available even in the protection status are indicated by an ○; those not available are indicated by an ×.

4.6 Example Programs

This section shows remote programming examples that use GPIB or RS-232C interface.

The example programs introduced here assume that you use Windows95/98/NT/2000 and Microsoft Visual Basic (VER4.0 or later), and use National Instruments NI-488.2M-compatible GPIB board or Agilent Technologies HP-IB board. Furthermore, it requires VISA (Virtual Instrument Software Architecture) library.

To use VISA library with Visual Basic, the following steps are needed.

- 1) Obtain a copy of VISA library. Recent GPIB/HP-IB board may come with it as standard or option. Or some product CD-ROM such as LabVIEW includes it. You can also download the library at <http://www.ni.com>.
- 2) Install the VISA Library.
- 3) Add VISA32.BAS and VPPTYPE.BAS to your Visual Basic project. Normally these files are placed in the c:\vxi\np\winnt\include folder (though winnt portion differs depending on OS version).

Although the examples use GPIB, you can replace the string passed to viOpen function with "ASRL1" or "ASRL2" to switch the programs using serial COM1 or COM2 port respectively.

Sample program 1

This program sets test conditions for the TOS6200 via the GPIB interface, performs testing, and displays test results on the message box. Commands used with the RS-232C interface are given as comments.

```
Private Sub Command1_Click()
    'Writing style is based on VISA 1.20 or 2.01
    '-----

    Dim vi As Long, tos As Long
    Dim vs As Long

    'Initialize VISA library
    vs = viOpenDefaultRM(vi)

    'Open GPIB or COM1 port for tos
    vs = viOpen(vi, "GPIB::3", vbNull, 10, tos)
    'vs = viOpen(vi, "ASRL1", vbNull, 10, tos)

    'Sets attributes if RS232
    Dim lIntfType As Long
    vs = viGetAttribute(tos, VI_ATTR_INTF_TYPE, lIntfType)
    If lIntfType = VI_INTF_ASRL Then
        vs = viSetAttribute(tos, VI_ATTR_ASRL_BAUD, 9600)
        vs = viSetAttribute(tos, VI_ATTR_ASRL_PARITY, VI_ASRL_PAR_NONE)
        vs = viSetAttribute(tos, VI_ATTR_ASRL_DATA_BITS, 8)
        vs = viSetAttribute(tos, VI_ATTR_ASRL_STOP_BITS, VI_ASRL_STOP_TWO)
        vs = viSetAttribute(tos, VI_ATTR_ASRL_FLOW_CNTRL, VI_ASRL_FLOW_XON_XOFF)
    End If

    Const DSR_READY = 1: Const DSR_INVSET = 2: Const DSR_TEST = 4: Const DSR_TESTON = 8
    Const DSR_PASS = 16: Const DSR_FAIL = 32: Const DSR_STOP = 64: Const DSR_PROTECTION = 128
    Const LOWER_FAIL = 2: Const UPPER_FAIL = 4
    Const OHP = 1: Const OHTP = 2: Const OVLD = 4: Const VL = 8
    Const REN = 16

    Dim r As Long, c As Long
    Dim strCommand As String, strRdBack As String, DSR As Integer, Result As String
    strRdBack = Space(255)

    'Device Clear
    vs = viClear(tos)

    'strCommand = "SILENT 1" + vbCrLf: vs = viWrite(tos, strCommand, Len(strCommand), r)
    'strCommand = "CLR" + vbCrLf: vs = viWrite(tos, strCommand, Len(strCommand), r)

    'FREQUENCY 50Hz,CURRENT 25A,UPPER 0.1ohm LOWER 0.015ohm ON,OFFSET OFF TOMER 60sec ON
    '-----

```

```

strCommand = "FUNCTION 0" + vbCrLf: vs = viWrite(tos, strCommand, Len(strCommand), r)
strCommand = "FREQ 50" + vbCrLf: vs = viWrite(tos, strCommand, Len(strCommand), r)
strCommand = "CURRENT 25.0" + vbCrLf: vs = viWrite(tos, strCommand, Len(strCommand), r)
strCommand = "UPPER 0.100" + vbCrLf: vs = viWrite(tos, strCommand, Len(strCommand), r)
strCommand = "LOWER 0.015,1" + vbCrLf: vs = viWrite(tos, strCommand, Len(strCommand), r)

strCommand = "OFFSET OFF" + vbCrLf: vs = viWrite(tos, strCommand, Len(strCommand), r)
strCommand = "TIMER 60.0,1" + vbCrLf: vs = viWrite(tos, strCommand, Len(strCommand), r)
strCommand = "PASSHOLD HOLD" + vbCrLf: vs = viWrite(tos, strCommand, Len(strCommand), r)
strCommand = "DSE #HFF" + vbCrLf: vs = viWrite(tos, strCommand, Len(strCommand), r)

Do
    strCommand = "DSR?" + vbCrLf: vs = viWrite(tos, strCommand, Len(strCommand), r)
    vs = viRead(tos, strRdBack, 255, c)
Loop While (Val(strRdBack) <> DSR_READY)

strCommand = "START" + vbCrLf: vs = viWrite(tos, strCommand, Len(strCommand), r)

Do
    strCommand = "MON?" + vbCrLf: vs = viWrite(tos, strCommand, Len(strCommand), r)
    vs = viRead(tos, strRdBack, 255, c)
    DSR = Val(Left$(strRdBack, InStr(1, strRdBack, ",") - 1))
    Result = Left$(strRdBack, c - 2)

    If DSR = DSR_STOP Then Exit Do

Loop While (DSR = DSR_READY Or DSR = DSR_TESTON Or DSR = DSR_TEST + DSR_TESTON)

Select Case DSR
    Case DSR_STOP
        MsgBox ("USER CANCEL! " + Result)

    Case DSR_PASS
        MsgBox ("PASS! " + Result)

    Case DSR_FAIL
        strRdBack = Space(255)
        strCommand = "FAIL?" + vbCrLf: vs = viWrite(tos, strCommand, Len(strCommand), r)
        vs = viRead(tos, strRdBack, 255, c)

        If Val(strRdBack) = LOWER_FAIL Then MsgBox ("LOWER FAIL! " + Result)

        If Val(strRdBack) = UPPER_FAIL Then MsgBox ("UPPER FAIL! " + Result)

    Case DSR_PROTECTION
        strRdBack = Space(255)
        strCommand = "PROT?" + vbCrLf: vs = viWrite(tos, strCommand, Len(strCommand), r)
        vs = viRead(tos, strRdBack, 255, c)

```

```

'Switches to the MAIN screen.
'Test frequency 50 Hz.
'Test current 25.0 A.
'Upper reference value 0.100Ω
'Lower reference value 0.015Ω
', ON.
'Offset function OFF.
'Timer function 60.0s, ON.
'PASS holding function HOLD.
'Sets the device enable status
'enable register to FFH.

'Checks the device enable
'register and awaits a "Ready"
'status.

'Starts the test on receiving a
'"Ready."

'Uses the MON? command to read
'out a DSR value, measured
'values, and other parameters.
'Extracts a DSR value.
'Places other measured values
'into variables.
'Exits loop when the STOP
'switch is pressed.
'Repeats steps until the test
'ends.
'Displays the test result.

'STOP switch was pressed
'during testing.

'Displays the PASS test result.

'Reads the contents of the fail
'register to determine which
'reference value was violated.
'Displays the LOWER FAIL test
'result.
'Displays the UPPER FAIL test
'result.

'Reads the protection register
'to determine the reason for
'protection.

```



```

If Val(strRdBack) = OHP Then MsgBox ("OVER HEAT PROTECTION! " + Result)
If Val(strRdBack) = OHTP Then MsgBox ("OVER HEAT TIMER PROTECTION! " + Result)
If Val(strRdBack) = OVLD Then MsgBox ("OVER LOAD PROTECTION! " + Result)
If Val(strRdBack) = VL Then MsgBox ("VOLT LIMIT PROTECTION! " + Result)
If Val(strRdBack) = REN Then MsgBox ("SIGNAL I/O PROTECTION! " + Result)

Case Else
    MsgBox ("ERROR!!")
End Select
strCommand = "STOP" & vbCrLf: vs = viWrite(tos, strCommand, Len(strCommand), r)

'Closes the port
vs = viClose(tos)
'Finalize VISA library
vs = viClose(vi)

End Sub

```

```

'Overheat protection was
'tripped.
'A current greater than 15 A
'was detected for 30 minutes.
'The overload protection (150
'VA) was tripped.
'The voltage limitation was
'tripped.
'The ENABLE signal for the
'SIGNAL I/O connector varied.

```

```

'Check results and press the
'STOP switch.

```

```

'Closes the port.

```

```

'Closes the VISA library.

```

sample program 2

This program sets test conditions for three TOS6200 memory addresses via the GPIB interface, sets memory numbers to program memory, and prepares for AUTO execution of testing.

Option Explicit

```
Private Sub Command1_Click()
    'Writing style is based on VISA 1.2
    '-----
    Dim vi As Long, tos As Long
    Dim vs As Long

    'Initialize VISA library
    vs = viOpenDefaultRM(vi)

    'Open GPIB or COM1 port for tos
    vs = viOpen(vi, "GPIB::3", vbNull, 10, tos)

    'vs = viOpen(vi, "ASRL1", vbNull, 10, tos)

    'Sets attributes if RS232
    Dim lIntfType As Long
    vs = viGetAttribute(tos, VI_ATTR_INTF_TYPE, lIntfType)
    If lIntfType = VI_INTF_ASRL Then
        vs = viSetAttribute(tos, VI_ATTR_ASRL_BAUD, 9600)
        vs = viSetAttribute(tos, VI_ATTR_ASRL_PARITY, VI_ASRL_PAR_NONE)
        vs = viSetAttribute(tos, VI_ATTR_ASRL_DATA_BITS, 8)
        vs = viSetAttribute(tos, VI_ATTR_ASRL_STOP_BITS, VI_ASRL_STOP_TWO)
        vs = viSetAttribute(tos, VI_ATTR_ASRL_FLOW_CNTRL, VI_ASRL_FLOW_XON_XOFF)
    End If

    Dim r As Long
    Dim strCommand As String

    'Device Clear
    vs = viClear(tos)

    'strCommand = "silent 1" & vbCrLf: vs = viWrite(tos, strCommand, Len(strCommand), r)
    'strCommand = "CLR" & vbCrLf: vs = viWrite(tos, strCommand, Len(strCommand), r)

    strCommand = "FUNCTION 0" & vbCrLf: vs = viWrite(tos, strCommand, Len(strCommand), r)

    strCommand = "MEMORY 20," & Chr$(34) & "TEST1" & Chr$(34) & ",25.0,0.1,0.020,60.0,50,ON,OFF,ON" & vbCrLf
    vs = viWrite(tos, strCommand, Len(strCommand), r)

```

'Initializes the VISA library.

'Opens the port.

'Opens the GPIB port.
'Address 3.

'Opens the COM1 port.
'When using the RS-232C interface, remove the comment from this line and add it to the line of GPIB.

'Enter communication settings for the RS-232C interface.

'Device clear.

'Device clear performed when using GPIB.

'RS-232C command.

'The RS-232C interface uses the CLR command.

'Sets test conditions to MEM20.



```
strCommand = "MEMORY 21," + Chr$(34) + "TEST2" + Chr$(34) + ",10.0,0.1,0.020,4.0,50,ON,OFF,ON" + vbCrLf 'Sets test conditions to  
vs = viWrite(tos, strCommand, Len(strCommand), r) 'MEM21.  
  
strCommand = "MEMORY 22," + Chr$(34) + "TEST3" + Chr$(34) + ",10.0,0.2,0.020,4.0,50,ON,OFF,ON" + vbCrLf 'Sets test conditions to  
vs = viWrite(tos, strCommand, Len(strCommand), r) 'MEM22.  
  
strCommand = "FUNCTION 2" + vbCrLf: vs = viWrite(tos, strCommand, Len(strCommand), r) 'Switches to AUTO EDIT  
'screen.  
  
strCommand = "PRGNEW 10" + vbCrLf: vs = viWrite(tos, strCommand, Len(strCommand), r) 'Clears the 10th program.  
  
strCommand = "PRGNAME 10," + Chr$(34) + "TEST_SAMPLE" + Chr$(34) + vbCrLf 'Names the 10th program.  
vs = viWrite(tos, strCommand, Len(strCommand), r)  
  
strCommand = "PRGEDIT 10,0,20,0.5" + vbCrLf: vs = viWrite(tos, strCommand, Len(strCommand), r) 'Stores MEM20, MEM21, and  
strCommand = "PRGEDIT 10,1,21,1.5" + vbCrLf: vs = viWrite(tos, strCommand, Len(strCommand), r) 'MEM22 into the 10th  
strCommand = "PRGEDIT 10,2,22,2.5" + vbCrLf: vs = viWrite(tos, strCommand, Len(strCommand), r) 'program.  
  
'Close the port  
vs = viClose(tos) 'Closes the port.  
'Finalize VISA library  
vs = viClose(vi) 'Closes the VISA library.  
  
End Sub
```

sample program 3

This program runs AUTO execution of the 10th program created in sample program 2 and displays the results in the message box.

Option Explicit

Private Sub Command1_Click()

'Writing style is based on VISA 1.20 or 2.01

'-----

Dim vi As Long, tos As Long

Dim vs As Long

'Initialize VISA library

vs = viOpenDefaultRM(vi)

'Open GPIB or COM1 port for tos

vs = viOpen(vi, "GPIB::3", vbNull, 10, tos)

'vs = viOpen(vi, "ASRL1", vbNull, 10, tos)

'Sets attributes if RS232

Dim lIntfType As Long

vs = viGetAttribute(tos, VI_ATTR_INTF_TYPE, lIntfType)

If lIntfType = VI_INTF_ASRL Then

vs = viSetAttribute(tos, VI_ATTR_ASRL_BAUD, 9600)

vs = viSetAttribute(tos, VI_ATTR_ASRL_PARITY, VI_ASRL_PAR_NONE)

vs = viSetAttribute(tos, VI_ATTR_ASRL_DATA_BITS, 8)

vs = viSetAttribute(tos, VI_ATTR_ASRL_STOP_BITS, VI_ASRL_STOP_TWO)

vs = viSetAttribute(tos, VI_ATTR_ASRL_FLOW_CNTRL, VI_ASRL_FLOW_XON_XOFF)

End If

Const DSR_READY = 1: Const DSR_INVSET = 2: Const DSR_TEST = 4: Const DSR_TESTON = 8

Const DSR_PASS = 16: Const DSR_FAIL = 32: Const DSR_STOP = 64: Const DSR_PROTECTION = 128

Const LOWER_FAIL = 2: Const UPPER_FAIL = 4

Const OHP = 1: Const OHTP = 2: Const OVLD = 4: Const VL = 8

Const REN = 16

Dim r As Long, c As Long

Dim strCommand As String, strRdBack As String, DSR As Integer, Result As String

strRdBack = Space(255)

'Device Clear

vs = viClear*(tos)

'strCommand = "SILENT 1" + vbCrLf: vs = viWrite(tos, strCommand, Len(strCommand), r)

'Initializes the VISA library.

'Opens the port.

'Opens the GPIB port. Address 3

'Opens the COM1 port. When

'using the RS-232C interface,

'remove the comment from this

'line and add it to the line of

'GPIB.

'Enter communication settings

'for the RS-232C interface.

'Definition of the device

'status register.

'Definition of the fail

'register.

'Definition of the protection

'register.

'Device clear.

'Device clear performed when

'using GPIB.

'RS-232C command.

```

'strCommand = "CLR" + vbCrLf:      vs = viWrite(tos, strCommand, Len(strCommand), r)
                                     'The RS-232C interface uses
                                     'the CLR command.

strCommand = "FUNCTION 1" & vbCrLf: vs = viWrite(tos, strCommand, Len(strCommand), r)
                                     'Switches to AUTO screen.
strCommand = "PRGTEST 10" & vbCrLf: vs = viWrite(tos, strCommand, Len(strCommand), r)
                                     'Recalls the 10th program.
strCommand = "PASSHOLD HOLD" + vbCrLf: vs = viWrite(tos, strCommand, Len(strCommand), r)
                                     'Sets PASS HOLD time to HOLD.
strCommand = "DSE #HFF" + vbCrLf:   vs = viWrite(tos, strCommand, Len(strCommand), r)
                                     'Sets the device status enable
                                     'register to FFH.

Do
    strCommand = "DSR?" + vbCrLf: vs = viWrite(tos, strCommand, Len(strCommand), r)
    vs = viRead(tos, strRdBack, 255, c)
    Loop While (Val(strRdBack) <> DSR_READY)
                                     'Checks the device status
                                     'register and awaits a "Ready"
                                     'setting.

strCommand = "START" + vbCrLf: vs = viWrite(tos, strCommand, Len(strCommand), r)
                                     'Starts the test because
                                     '"Ready" was received.

Do
    strCommand = "MON?" + vbCrLf: vs = viWrite(tos, strCommand, Len(strCommand), r)
    vs = viRead(tos, strRdBack, 255, c)
    DSR = Val(Left$(strRdBack, InStr(1, strRdBack, ",") - 1))
    Result = Left$(strRdBack, c - 2)
                                     'Uses MON? command to read out
                                     'the DSR value, measured
                                     'values, and other parameters.
                                     'Extracts the DSR value.
                                     'Places the other measured
                                     'values into variables.

    If DSR = DSR_STOP Then Exit Do
                                     'Exits the loop when STOP
                                     'switch is pressed.

Loop While (DSR = DSR_READY Or DSR = DSR_TESTON Or DSR = DSR_TEST + DSR_TESTON)
                                     'Repeats steps until the test
                                     'ends.

Select Case DSR
    Case DSR_STOP
        MsgBox ("USER CANCEL! " + Result)
                                     'STOP switch was pressed
                                     'during testing.

    Case DSR_PASS
        MsgBox ("PASS! " + Result)
                                     'Displays the PASS test result.

    Case DSR_FAIL
        strRdBack = Space(255)
        strCommand = "FAIL?" + vbCrLf: vs = viWrite(tos, strCommand, Len(strCommand), r)
        vs = viRead(tos, strRdBack, 255, c)
                                     'Reads the contents of the fail
                                     'register to determine which
                                     'reference value was violated.

        If Val(strRdBack) = LOWER_FAIL Then MsgBox ("LOWER FAIL! " + Result)
                                     'Displays the LOWER FAIL test
                                     'result.

        If Val(strRdBack) = UPPER_FAIL Then MsgBox ("UPPER FAIL! " + Result)
                                     'Displays the UPPER FAIL test
                                     'result.

    Case DSR_PROTECTION
        strRdBack = Space(255)
        strCommand = "PROT?" + vbCrLf: vs = viWrite(tos, strCommand, Len(strCommand), r)
        vs = viRead(tos, strRdBack, 255, c)
                                     'Reads the protection register
                                     'to determine the reason for
                                     'protection.

        If Val(strRdBack) = OHP Then MsgBox ("OVER HEAT PROTECTION! " + Result)
                                     'The overheat protection was
                                     'tripped.

        If Val(strRdBack) = OHTP Then MsgBox ("OVER HEAT TIMER PROTECTION! " + Result)
                                     'A current greater than 15 A
                                     'was detected for 30 minutes.

```



```

    If Val(strRdBack) = OVLd Then MsgBox ("OVER LOAD PROTECTION! " + Result)
    If Val(strRdBack) = VL Then MsgBox ("VOLT LIMIT PROTECTION! " + Result)
    If Val(strRdBack) = REN Then MsgBox ("SIGNAL I/O PROTECTION! " + Result)

    Case Else
        MsgBox ("ERROR!!")
    End Select
    strCommand = "STOP" & vbCrLf: vs = viWrite(tos, strCommand, Len(strCommand), r)

    'Closes the port
    vs = viClose(tos)
    'Finalize VISA library
    vs = viClose(vi)

End Sub
```

```
'The overload protection (150
'VA) was tripped.
'The voltage limitation was
'tripped.
'The ENABLE signal for the
'SIGNAL I/O connector varied.
```

```
'Check the result and press the
'STOP switch.
```

```
'Closes the port.
```

```
'Closes the VISA library.
```

Chapter 5 Part Names and Functions

This chapter gives the names and describes the functions of the switches, indicators, connectors, and other parts on the front and rear panels of the TOS6200.

5.1 Front Panel

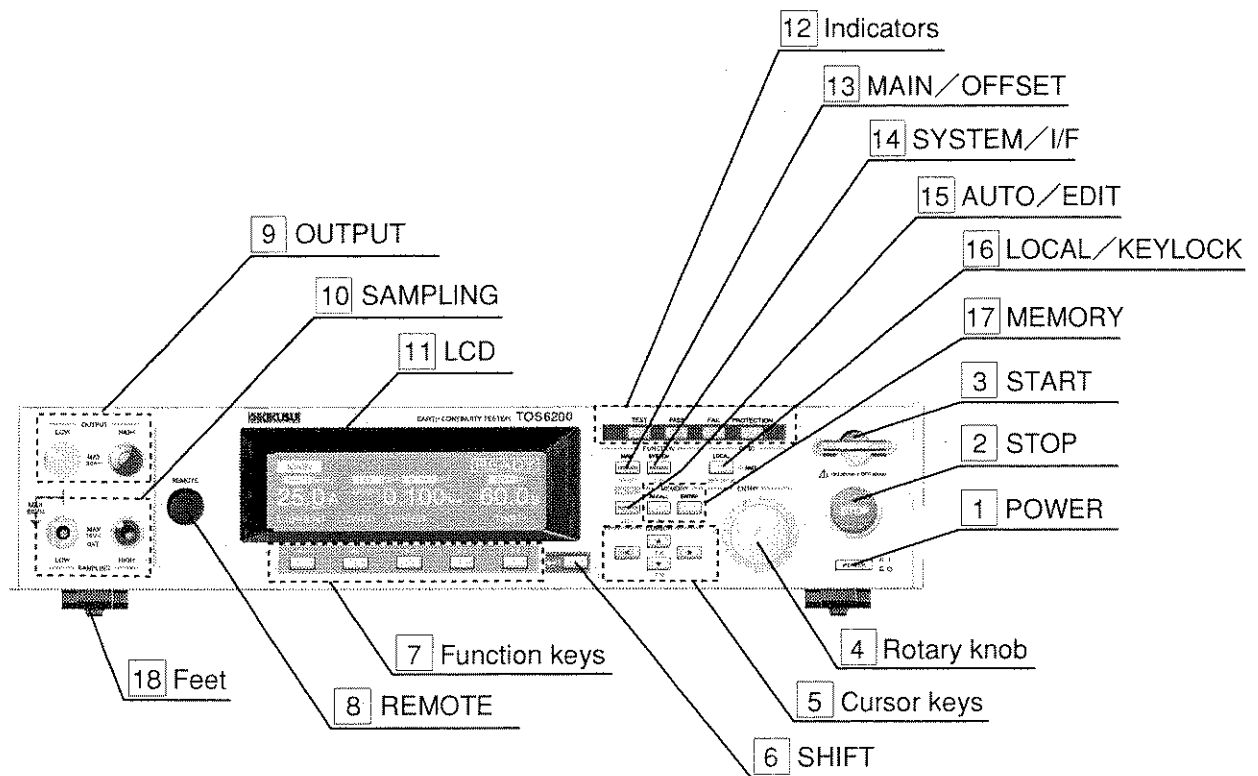

Fig. 5-1 Front Panel

1 POWER

Turns the tester power ON/OFF. When power is turned ON (I), the tester starts under the test conditions set when power was turned OFF (O).

Turning the power ON with the SHIFT key held down initialized the tester to factory-set settings. For more information, see 2.11, Initialize.

NOTE

- Initializing clears the contents of all panel memories and programs stored. Check all data in memories and programs before initializing.

2 STOP

This switch is used to stop a test.

Press this switch to cancel a PASS, FAIL, or PROTECTION status.

Pressing this switch places the tester in ready status.

3 START

This switch is used to start a test.

Press this switch when "READY" is displayed on the LCD to begin testing.

During testing, the TEST LED indicator lights and a "TEST" indication appears on the LCD.

4 Rotary knob

In ready status : Used to set test conditions and other parameters displayed on the LCD.

During testing : Used to change the test current.

5 Cursor keys

Used to move the cursor when setting test conditions or other parameters.

6 SHIFT

Used to switch the function menu or to extend a key function.

Switching on power with this key held down initializes tester settings to their factory-set settings. For more information, see 2.11, Initialize.

NOTE

- Initializing clears the contents of all panel memories and programs stored. Check all data in memories and programs before initializing.
-

7 Function keys

Provide functions corresponding to the F1 to F5 menus displayed on the LCD.

8 REMOTE

This terminal is used to connect an optional remote control box or dedicated test probe.

9 OUTPUT

These current output terminals are used to connect current output wires for testing.

CAUTION

- The maximum input voltage between the OUTPUT terminals and casing is 20 V AC/DC or less. Do not apply an external voltage exceeding this limit.
-

10 SAMPLING

These voltage input terminals are used to connect voltage measuring wires for four-terminal measurements.

-
- ⚠ CAUTION** • The maximum input voltage between the SAMPLING terminals is 10 V AC/DC or less. Do not apply external voltage exceeding this limit.
-

11 LCD

Displays information, including the range of set values and measured values.

12 Indicators

• TEST

This LED indicates that testing is underway.

Blinks for contact checks when the contact check is set to ON standby.

• PASS

This LED gives the test result.

This LED lights to indicate that a test result is PASS.

For tests that do not use the timer function, a pass/fail judgement is not made.

• FAIL

This LED gives the test result.

When the test result has been judged as FAIL, this LED lights up.

• PROTECTION

This LED indicates that an internal protection function has been tripped, and lights under the following conditions.

- (1) The tester's internal temperatures have risen to unusual levels, tripping the overheat protection.
- (2) A current of 15 A or greater was detected for 30 minutes or more during testing.
- (3) Power exceeding 150 VA was detected during testing.
- (4) An output terminal voltage exceeding 5.6 V was detected (when the measured value was not judged FAIL) during testing.
- (5) The ENABLE signal of the SIGNAL I/O connector was changed to high or low levels.

To clear each condition, take the following steps.

- (1) Let internal temperatures fall to normal levels, then press the STOP switch.
- (2) Stop testing for 30 minutes or more, then press the STOP switch.
- (3) Press the STOP switch.
- (4) Press the STOP switch.
- (5) Press the STOP switch.

13 MAIN / OFFSET

Pressing this key lights the LED and displays the test conditions setup screen (MAIN) on the LCD. Generally, testing is performed from this screen.

Pressing this key with the SHIFT key held down displays the offset measurement screen (OFFSET).

14 SYSTEM / I/F

This key is used to make the system settings of the tester.

Pressing this key causes its LED to light and displays the system setup screen on the LCD (SYSTEM).

Pressing this key with the SHIFT key held down displays the interface setup screen (INTERFACE) on the LCD.

15 AUTO / EDIT

Pressing this key turns its LED on and displays the program execution screen on the LCD (AUTO READY).

Pressing this key with the SHIFT key held down displays the program editing screen (AUTO EDIT) to enable program editing.

16 LOCAL / KEYLOCK

Pressing this key while the tester is being controlled remotely through the GPIB or RS-232C interface restores local control.

Pressing this key with the SHIFT key held down under local control activates the key lock function. In the key lock status, "KEYLOCK" appears on the LCD. Under remote control, the LED to the right of this key lights.

17 MEMORY

- RECALL/STORE key

Press this key to recall panel memory.

Change the memory number using the rotary knob, then press the ENTER key next to this key. This recalls the contents of the specified memory number.

Pressing this key with the SHIFT key held down enables test conditions to be stored to memory. The procedure is the same as for recall.

- ENTER key

Used to accept an entered memory number when recalling panel memory or when saving test conditions to panel memory.

18 Feet

Used to raise the front panel of the meter to get a better view of the LCD screen or improve the operability of the keys.

Pull the feet forward until you hear them click.

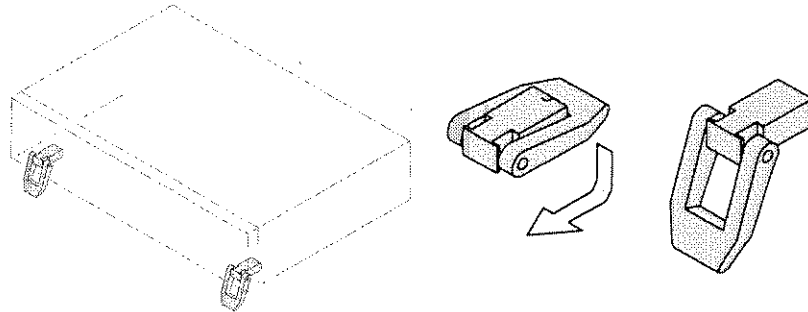

Fig. 5-2 How to use the feet

⚠ CAUTION • When you use the tester with the feet pulled forward, do not place any article on it nor exert forces no it.

5.2 Rear Panel

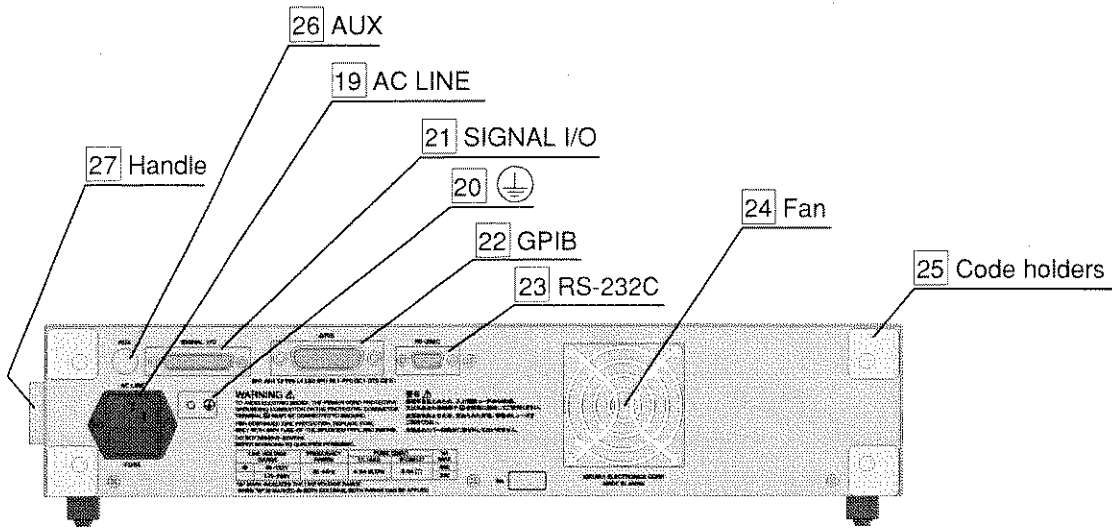

Fig. 5-3 Rear Panel

19 AC LINE

This is the connector for AC power cord that supplies power to the tester.
Connect the supplied AC power cable here. The fuse holder is also found here.

WARNING • Improper handling of the AC LINE connector may result in electric shock. Follow the instructions given in 1.6, "Connecting the AC Power Cord."

20

This is the protective grounding terminal.

WARNING • Always provide grounding. For more information, see 1.7, Grounding.

21 SIGNAL I/O

This D-sub 25-pin connector is used for remote control of testing start and stop operations, or to check the tester status according to an output signal.

For more information, see 3.2, SIGNAL I/O Connector.

22 GPIB

This connector is used to connect a GPIB cable for remote control of the tester through a PC or other device via the GPIB interface.

23 RS-232C

This connector connects an RS-232C cable for remote control of the tester is remote through a PC or other device via the RS-232C interface.

24 Fan

Used to cool the tester interior.

-
- ⚠ CAUTION** • Provide adequate space at the air intakes on the side panels and fan exhaust port to allow sufficient air flow.
-

25 Cord holders

Used to wind the AC power cord when the tester is not in use.

-
- ⚠ CAUTION** • Never use the tester in an upright position, since doing so with the cord holders serving as feet renders the tester dangerously unstable.
-

26 AUX

This connector is used to extend the functionality of the TOS6200.

27 Handle

Used to carry the tester.

This chapter explains the maintenance and inspection of the tester. To maintain high performance for an extended period, perform maintenance and inspect the tester regularly.

6.1 Cleaning

If the panel surface is stained, lightly wipe the stain using a cloth moistened with a water-diluted neutral detergent.

-
- ⚠ WARNING** • Before cleaning, be sure to turn OFF the POWER switch and to unplug the power cord.
 - ⚠ CAUTION** • Do not use volatile substances such as thinner or benzene for cleaning, as they may cause discoloration or erase printed characters, clouded display and so on.
-

6.2 Inspection

-
- ⚠ WARNING** • Any break or cracking in the covering greatly increases the risk of electric shock or fires. If you find any breaks or cracks, immediately discontinue any use of the instrument.
-

To purchase accessories, please contact your Kikusui distributor/agent.

■ AC power cord

Check that the covering is free of breaks or cracks, that the plug is free of looseness or cracks, and that the cable itself is not damaged.

■ Test leads

Check that the covering and leads are free of damage.

6.3 Checking and Replacing the Fuse

WARNING

- To avoid electric shock, always turn off the POWER switch and unplug the AC power cord from an electrical outlet before performing inspections or replacing the fuse.
- Make sure that the replacement fuse is of the correct shape, rating, and characteristics for tester specifications. Never use a fuse having a different rating; never short-circuit the fuse holder.

1. Turn off the POWER switch and unplug the AC power cord from the electrical outlet.
2. Disconnect the AC power cord from the AC LINE connector on the rear panel.
3. Use a screwdriver to remove the fuse holder, as shown in Fig. 6-1.

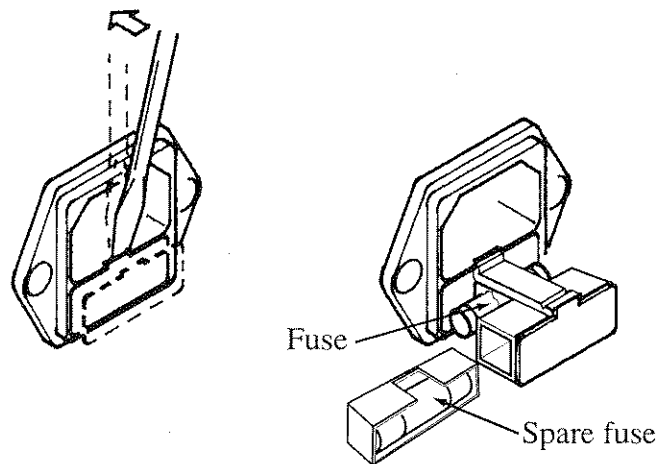

Fig. 6-1 Removing the Fuse Holder

LINE VOLTAGE RANGE	FREQUENCY RANGE	FUSE (250V)		VA MAX
		UL198G	IEC60127	
● 85-132V	45-65Hz	6.3A SLOW	6.3A (T)	450
170-250V				330

NOTE

- UL and IEC standards provide different designations for pre-arcing time-current characteristics of fuses. Use a fuse that complies with one or both of these standards.

6.4 Replacing the Cooling Fan and Backup Battery

- ⚠ WARNING** • Since replacement of the cooling fan or backup battery involves removing the cover, all such work should be performed by our service personnel. If replacement is necessary, please contact Kikusui distributor/agent.
-

■ Cooling fan

The cooling fan within the tester is rated for a service life of 60,000 hours.

The cooling fan adjusts its rotational rate depending on the internal temperatures of the tester, and actual service life will vary depending on the tester's service conditions. However, we recommend replacing the fan roughly every 60,000 hours. We also recommend regular internal inspections and cleaning at the same interval.

■ Backup battery

The TOS6200 uses a lithium battery for memory backup.

If the battery is exhausted, the memory is unable to retain test conditions and other data. Although service life depends on the usage environment, we generally recommend replacing the battery every 3 years from the purchase date. We also recommend regular internal inspections and cleaning at the same interval.

6.5 Calibration

Regular calibration is required to maintain long-term accuracy of any measurement instrument. Please request our calibration service to have calibration performed.

6.6 In Case of Problems

The following problems do not necessarily indicate failures. Please make the following inspections before requesting repairs.

Symptom	Check Item	Chapter/section to be referred to	Page number
The tester does not start when the POWER switch is pressed.	• Check that the AC power code is connected.	1.6 "Connecting the AC Power Code"	1-5
	• Check that the fuse burns.	6.3 "Checking and Replacing the Fuse"	6-2
The LCD screen does not appear even when the POWER switch is pressed.	• Make sure that the contrast adjustment is correct.	2.5 "System Setup"	2-14
	• Make sure that ambient temperatures are not below the recommended operational limits.	General Specifications	7-5
The keys on the front panel do not work.	• Make sure that the key lock function is off.	2.9 "Key Lock"	2-26
	• Make sure that the tester is not being controlled remotely via the GPIB or RS-232C interface.	LOCAL key	5-4
The START key does not function.	• Check that no stop signal is being input.	Chapter 3 "REMOTE and SIGNAL I/O"	3-1
	• Check that the tester is not in PROTECTION, PASS, or FAIL status.	2.10 "Protection"	2-27
	• Check that the tester is not in the midst of system setup, interface setup, or program editing.		
	• Check that the tester is not currently saving or recalling information from panel memory.		
	• Make sure that the double action function is off.	ON/OFF for double action	2-16
	• Check that the "READY" indication is displayed on the LCD.		
	• Check that the "OVER VOLT" indication is blinked on the upper right part of the LCD.	2.2.1 "Setting Test Current" or 2.2.5 "Setting the Upper Reference Value"	2-4, 2-7
	• Check that the "UP<=LOW" indication is blinked on the upper right part of the LCD.	2.2.4 "Setting the Lower Reference Value" or 2.2.5 "Setting the Upper Reference Value"	2-6, 2-7
The fan does not run.	• The fan adjusts its rotational rate depending on the tester's internal temperatures; if the internal temperatures are sufficiently low, the fan will not run. If "OVER HEAT" appears on the LCD and the fan is not running, the tester is defective.		

This chapter gives electrical and mechanical specifications for the TOS6200.

Basic performance

Item	Specifications
Output block	
Current setting range (*1)	3.0 to 30.0 A AC (With respect to resistance resulting in output power of the maximum rated Output or less and an output terminal voltage of 5.4 V or less)
Resolution	0.1 A
Accuracy	±(1% of setting + 0.2A)
Maximum rated output	150 VA (at output terminals)
Distortion factor	2% or less (with respect to 0.1 Ω pure resistance load of 10 A or greater)
Frequency	50/60 Hz, sine wave (selectable)
Accuracy	±200 ppm
Open terminal voltage	6 Vrms or less
Output method	PWM switching method
Output ammeter	
Measurement range	0.0 to 33.0 A AC
Resolution	0.1 A
Accuracy	± (1% of reading + 0.2 A)
Response	Mean value response/rms value display (response time: 200 ms)
Hold function	The current measured at the end of test is held during the PASS or FAIL interval
Output voltmeter	
Measurement range	0.00 to 6.00 V AC
Resolution	0.01 V
Accuracy	± (1% of reading + 0.02 V)
Response	Mean value response/rms value display (response time: 200 ms)
Hold function	The voltage measured at the end of test is held during the PASS or FAIL interval
Ohmmeter	
Measurement range	0.001 to 1.200 Ω
Resolution	0.001 Ω
Offset cancel function	0.000 to 1.200 Ω (Offset ON/OFF function provided)
Accuracy	± (2% of reading + 0.003 Ω)
Hold function	The resistance measured at the end of test is held during the PASS or FAIL interval

Item		Specifications
Pass/fail judgment function		
Judgment system		Window comparator system <ul style="list-style-type: none"> • If a resistance value equal to or greater than the upper reference value is detected, a FAIL determination is returned. • If a resistance value equal to or less than the lower reference value is detected, a FAIL determination is returned. • If a resistance value has been judged as FAIL, the tester shuts off the output and generates a FAIL signal. • If the set time elapses without abnormalities, the tester shuts off the output and generates a PASS signal.
Setting range for the upper reference value (UPPER)		0.001 to 1.200 Ω
Setting range for the lower reference value (LOWER)		0.001 to 1.200 Ω
Judgment accuracy		\pm (2% of UPPER + 0.003 Ω)
Calibration		Calibration is performed with the rms value of the sine wave, using a pure resistance load.
LED	PASS	Lights for approximately 0.2 sec when the measured value has been judged as PASS. It is lit continuously when the PASS holding time is set to HOLD.
	UPPER FAIL	Lights if a resistance value equal to or greater than the upper reference value is detected and judged FAIL.
	LOWER FAIL	Lights if the resistance value equal to or less than the lower reference value is detected and judged FAIL.
Buzzer		<ul style="list-style-type: none"> • The buzzer sounds for approximately 0.2 sec if the measured value has been judged as PASS. • The buzzer sounds continuously under the following condition: <ul style="list-style-type: none"> The measured value has been judged as PASS when the PASS holding time is set to HOLD. The measured value has been judged as UPPER FAIL. The measured value has been judged as LOWER FAIL. The buzzer volume for FAIL or PASS judgment are adjustable. Note that it cannot be adjusted individually since setting is shared with the setting for PASS.
Time		
Test time	Setting range	0.3 to 999 s Timer ON/OFF function is available.
	Accuracy	\pm (100 ppm of setting + 20 ms)

*1: Time limitation with respect to output

The heat radiation capacity at the output block of the tester is designed to be half the rated output, accounting for size, weight, cost, and other factors. Always use the tester within the limitation values given below. Use of the tester beyond these limits will cause the temperature of the output block to rise excessively, potentially tripping the internal protection circuit. In this case, suspend testing for approximately 30 minutes, then press the STOP switch. When temperatures fall to normal levels, the tester will revert to ready status.

Output time limitation			
Ambient temperature t ($^{\circ}\text{C}$)	Upper cutoff current I (A)	Pause time	Maximum allowable continuous test time
$t \leq 40^{\circ}\text{C}$ ($t \leq 104^{\circ}\text{F}$)	$15 < I \leq 30$	Equal to or greater than the test time	≤ 30 minutes
	$I \leq 15$	Not required	Continuous output possible

Interface and Other Functions

Item	Specifications			
REMOTE	5-pin DIN connector on the front panel An option may be connected to provide remote-controlled tester start/stop functions. <ul style="list-style-type: none"> Remote controller: RC01-TOS or RC02-TOS Test probe: LTP-2 			
SIGNAL I/O	D-SUB 25-pin connector on the rear panel			
	No.	Signal name	I/O	Description of signals
	1	PM0	I	2-digit BCD active-low input Input terminal of a panel memory/program select signal This select signal is latched at the rise of a strobe signal to recall the panel memory or program.
	2	PM1	I	
	3	PM2	I	
	4	PM3	I	
	5	PM4	I	
	6	PM5	I	
	7	PM6	I	
	8	PM7	I	
	9	STB	I	Input terminal of a panel memory/program strobe signal
	10	N.C		
	11	N.C		
	12	N.C		
	13	COM		Circuit common
	14	TEST ON	O	ON during testing
	15	TEST	O	ON during testing (not including the period of a current/voltage rise)
	16	PASS	O	ON for approximately 0.2 sec when a measured value has been judged as PASS. It is ON continuously when the PASS holding time is set to HOLD.
	17	U FAIL	O	Continuously ON if a measured value equal to or greater than the upper reference value is detected and judged FAIL.
	18	L FAIL	O	Continuously ON if a measured value equal to or below the lower reference value is detected and judged FAIL.
	19	READY	O	ON while the tester is in ready status
	20	PROTECTION	O	ON when PROTECTION status is in effect
	21	START	I	Start signal input terminal
	22	STOP	I	Stop signal input terminal
	23	ENABLE	I	Start signal's ENABLE signal input terminal
	24	+24V	O	+24 V internal power output terminal. Maximum output current is 100 mA.
	25	COM		Circuit common
	Input specifications			
	High-level input voltage	11 to 15 V	All input signals are controlled in active Low. The input terminal is pulled up to +12 V with a resistor. Leaving the input terminals open is equivalent to inputting a high-level signal.	
	Low-level input voltage	0 to 4 V		
	Low-level input current	-5 mA maximum		
	Input time width	5 ms minimum		

Item		Specifications
SIGNAL I/O	Output specifications	
	Output method	Open collector output (4.5 to 30 V DC)
	Output withstand voltage	30 V DC
	Output saturation voltage	Approximately 1.1 V (at 25°C)
	Maximum output current	400 mA (TOTAL)

Item		Specifications
AUX		Mini DIN 8-pin connector on the rear panel
RS-232C		D-SUB 9-pin connector on the rear panel (compliant with EIA-232-D) All functions except for the POWER switch and KEY LOCK function may be controlled remotely. Baud rate 9600, 19200, or 38400 bps
GPIB		Complies with IEEE Std.488-1978 All functions except for the POWER switch and KEY LOCK function may be controlled remotely. SH1,AH1,T6,TE0,L4,LE0,SR1,RL1,PP0,DC1,DT0,C0,E1
Display		240 x 64 dots LCD, which displays set values, measured values, judgment results, and other information.
Test function	AUTO	Performs testing (maximum 100 steps) under different test conditions.
	MAIN	Performs a single earth continuity test.
Memory function	AUTO	Provides programming of up to 100 different tests, each consisting of a maximum of 100 steps. (Note that the total number of steps is 500.)
	MAIN	100 maximum
Backup battery life		3 years or more (at 25°C)
TEST MODE		<ol style="list-style-type: none"> 1. PASS HOLD Allows a PASS judgment to be held for a specified holding time. 2. MOMENTARY Allows testing only while the START switch is pressed. 3. FAIL MODE Disables cancellation of FAIL or PROTECTION status using a stop signal from the remote control. 4. DOUBLE ACTION Allows testing only when the START switch is pressed within a half-second after the STOP switch is released. 5. CONTACT CHECK Enables the tester to detect a current flowing through the output terminals to begin testing.

General specifications

Item		Specifications
Environment		
Installation		Indoors and the altitude is less than 2,000 m
Warranty range	Temperature	5 to 35°C
	Humidity	20 to 80% RH (non condensing)
Operating range	Temperature	0 to 40°C
	Humidity	20 to 80% RH (non condensing)
Storage range	Temperature	-20 to 70°C
	Humidity	90% RH or less (non condensing)
Power requirement		
Allowable voltage range		100 V model : 85 to 132 V AC 100 V/200 V model : 85 to 132 V AC/170 to 250 V AC
Power consumption	At no load (READY)	100 V model : 70 VA or less 100 V/200 V model : 45 VA or less
	At rated load	100 V model : 450 VA max. 100 V/200 V model : 330 VA max.
Allowable frequency range		45Hz to 65Hz
Insulation resistance		30MΩ min. (500 V DC), between AC line and chassis
Withstanding voltage		1350 V AC (1 second), between AC line and chassis
Earth continuity		25 A AC/0.1Ω max.
EMC		<p>Complied with the following standards</p> <p>IEC61326-1:1997-03/A1:1998-05 Electrical Equipment for Measurement, Control and Laboratory Use - EMC requirements</p> <p>Radiated Emissions Class A Conducted Emissions Class A</p> <p>IEC61000-4-2:1995-01 / A1:1998-01 Electrostatic discharge</p> <p>IEC61000-4-3:1995-02 Radiated, radio-frequency, electromagnetic field IEC61000-4-4:1995-01 Electrical fast transient/Burst IEC61000-4-5:1995-02 Surge IEC61000-4-6:1996-04 Conducted disturbances IEC61000-4-11:1994-06 Voltage dips, short interruptions and voltage variations</p> <p>Under following conditions</p> <ol style="list-style-type: none"> Used test leadwire (TL11-TOS) which is supplied. Used the shielded cable which length is less than three meters when the SIGNAL I/O is used.
Safety		<p>Complied with the following standards</p> <p>IEC61010-1:1990-09 / A2:1995-07 Safety Requirements for Electrical Equipment for Measurement, Control and Laboratory Use</p> <p>TOS6200 is designed so that it is connected to a power supply of overvoltage category II as Class I equipment in environment of pollution degree 2.</p>

Item	Specifications
Physical dimensions (maximum)	430 (455) W×88 (140) H×270 (345) D mm
Weight	Approx. 9kg
Accessories	
AC power cord	1 piece
Test leadwire TL11-TOS	1 set
Short bar	2 pieces. (These are inserted between the OUTPUT and SAMPLING terminals.)
AC power fuse	2 pieces (2, including one spare in the fuse holder)
Operation manual	1 copy

GPIB interface

Function	Subset	Description
Source handshake	SH1	All functions operable
Acceptor handshake	AH1	All functions operable
Talker	T6	All functions operable, except for the talk-only function
Extended talker	TE0	No functions operable
Listener	L4	All functions operable, except for the listen-only function
Extended listener	LE0	No functions operable
Service request	SR1	All functions operable
Remote local	RL1	All functions operable
Parallel poll	PP0	No functions operable
Device clear	DC1	All functions operable
Device trigger	DT0	No functions operable
Controller	C0	No functions operable
Electrical interface	E1	Open collector

External dimensions

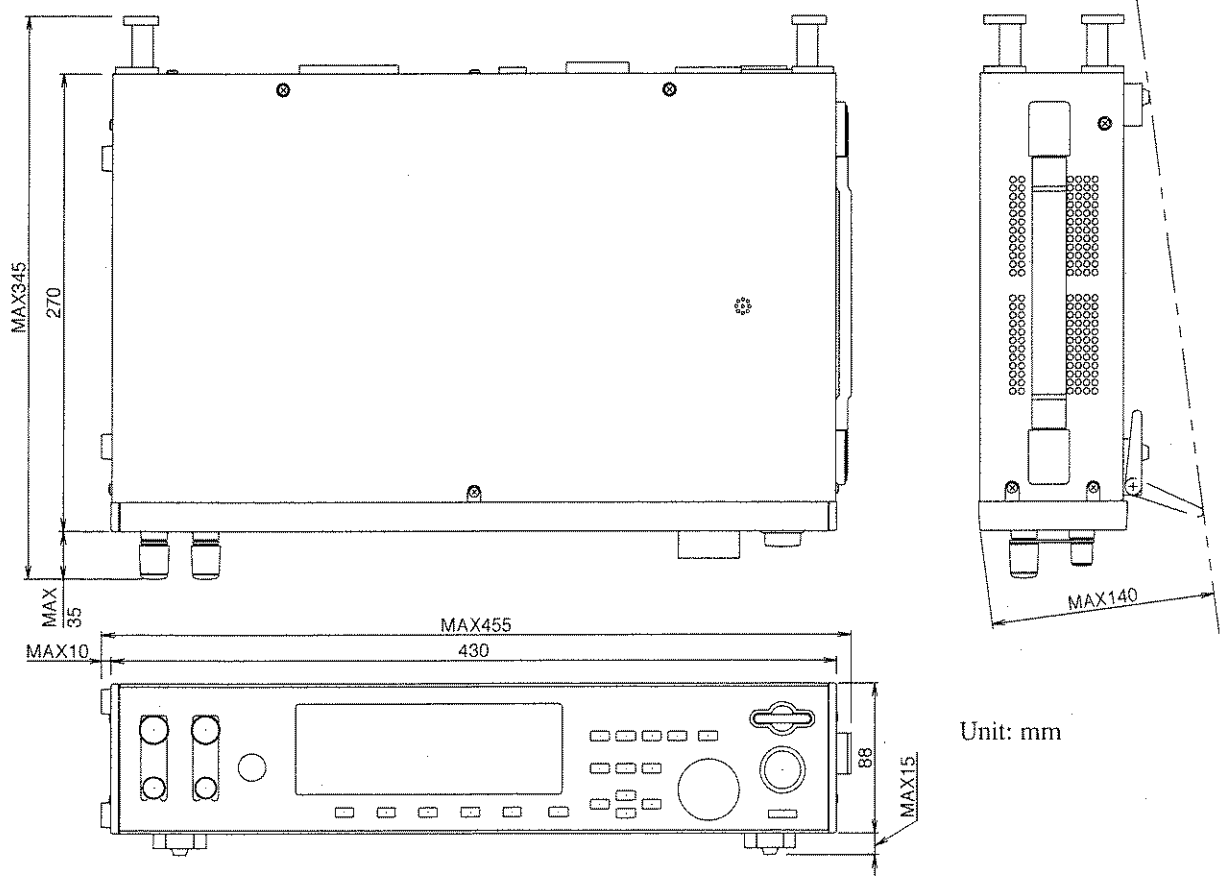

Fig. 7-1 External dimensions

Appendix

1. Operational Principle

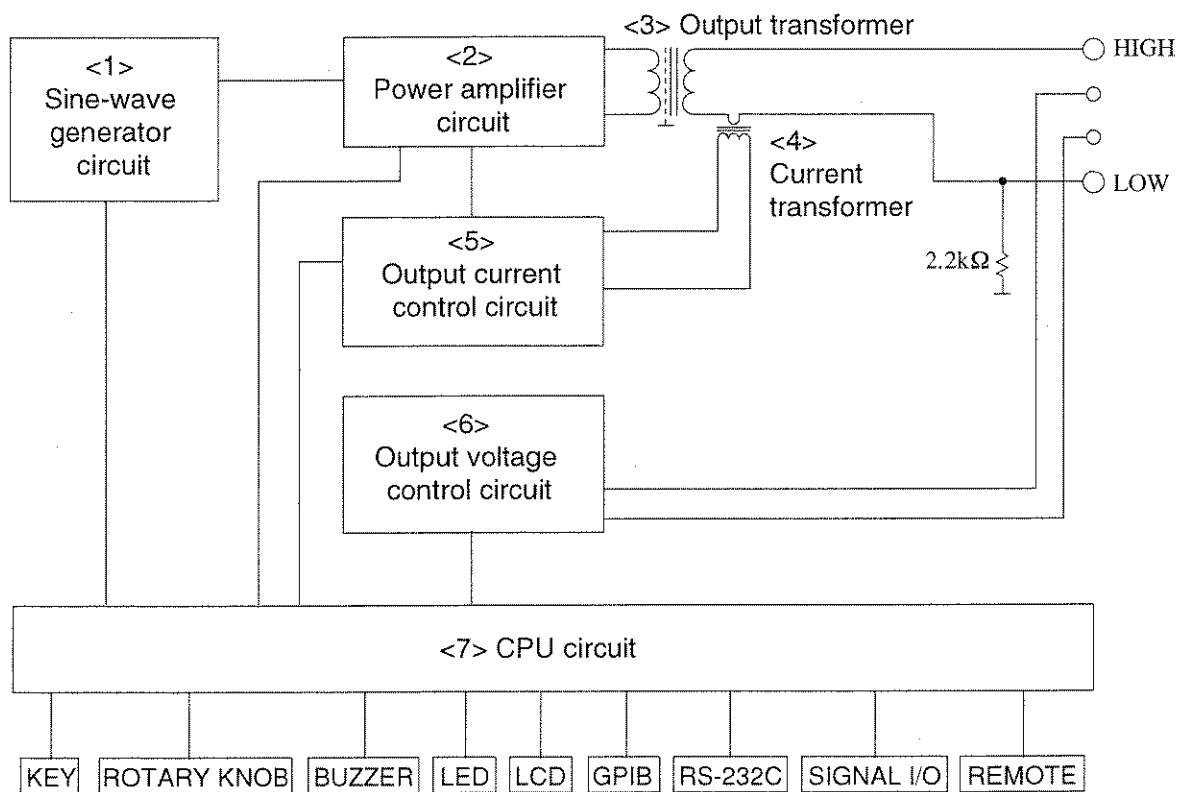

Fig. 1 Block Diagram

<1> Sine-wave generator circuit

Generates a reference sine wave of 50 or 60 Hz, controlled according to output voltage.

<2> Power amplifier circuit

Power-amplifies the reference sine wave in response to output to produce an input for the output transformer. This compact, lightweight PWM sine-wave inverter is capable of a maximum output of 150 VA, achieving a power conversion efficiency of 90%.

<3> Output transformer

This step-down transformer generates a rated output of 6 V/25 A, for which the secondary side is approximately 6 V when the primary side is 30 V.

<4> Current transformer

This transformer voltage-converts the output current and delivers the converted output to the current control circuit.

<5> Output current control circuit

Sends detected output current information to the power amplifier circuit for constant current flow at the output terminals. It also DC-converts the detected output current and displays averaged data as measurement values on the LCD.

<6> Output voltage control circuit

Sends the detected output voltage to the power amplifier circuit for constant voltage at the output terminals. It also DC-converts the detected output voltage and displays averaged data as measured values on the LCD.

<7> CPU circuit

Controls the output current, output voltage, resistance value, pass/fail judgment, test duration, buzzer, and others based on input information through panel key operations, the REMOTE terminal, SIGANL I/O connector, GPIB connector, or RS-232C connector. Also handles signal output to and communications with external devices.

2. ASCII Codes 20H to 7EH

NOTE

- In the TOS6200, 22H "", 27H "", 2CH ",", and 40H "@" are unavailable.
-

```
! " # $ % & ' ( ) * + , - . /
0 1 2 3 4 5 6 7 8 9 : ; < = > ?
@ A B C D E F G H I J K L M N O
P Q R S T U V W X Y Z [ \ ] ^ _
` a b c d e f g h i j k l m n o
p q r s t u v w x y z { | } ~
```

3. Summary of the Safety Standards for Earth Continuity Testing

Standard	Type test/routine test	Main test points	Test current	Allowable resistance value	Test time	Remarks
IEC 60065 1998 Audio, Video, and Similar Electronic Apparatus Safety Requirements	Type test (Test certifying conformity to the standard)	Between the following sections of class-I devices requiring grounding and parts <1> Accessible conducting parts <2> Protective shielding <3> Metal barriers	2.5 A AC or DC (30 A in Canada)	0.1 Ω or less	1 minute	<ul style="list-style-type: none"> • Test voltage must be 12 V or less. • Calculate a resistance value from the flowing current and voltage drop. • In measurements of resistance, do not include the value for the AC power cord's protective grounding wire.
	Routine test (100% test conducted in the production process)	Protective grounding pin for AC inlet on the device side (for devices with removable AC power cords) Protective grounding pin for the power plug (for devices with fixed AC power cords)	Order of 10 A AC	0.1 Ω or less 0.2 Ω or less	1 to 4 sec	<ul style="list-style-type: none"> • Use a power supply with a no-load voltage of 12 V or less. • Exercise care so that test results are not affected by the contact resistance between a tester's probe and the metal part being tested.
IEC 60204-1 1997 Electrical Equipment of Industrial Machines - Part 1: General Requirements	No distinction	Between all accessible conducting parts of class-I devices requiring grounding and	10 A or greater (50 or 60 Hz)	See Remarks (0.1 Ω or equivalent provided that the test current is 10 A).	10 sec or longer	The measured voltage value at a test point must not exceed the following values. When the effective sectional area of protective conductor is 1.0 mm ² or less: 3.3 V maximum 1.5 mm ² or less: 2.6 V maximum 2.5 mm ² or less: 1.9 V maximum 4.0 mm ² or less: 1.4 V maximum 6.0 mm ² or less: 1.0 V maximum

Standard	Type test/routine test	Main test points	Test current	Allowable resistance value	Test time	Remarks
IEC 60335-1 1994 Safety of Household and Similar Electrical Appliances - Part 1: General Requirements	No distinction	Between class-0 and -I devices and all accessible conducting parts of class-I devices and	Protective conductor terminal or protective grounding pin	<1> 25 A DC or 25 A AC or <2> 1.5 times the rated device current, whichever is greater.	0.1 Ω or less	Not specified • Use an AC or DC power supply with a no-load voltage of 12 V or less. • In case of doubts, continue testing until a steady state is attained. • Resistance measurements should not include the value for the AC power cord. • Exercise care so that the test results are not affected by the contact resistance between the end of a measuring probe and a metal part.
IEC 60601-1 1995 Medical Electrical Equipment - Part 1: General Requirements for Safety	No distinction	Between all accessible conducting parts of class-I devices requiring grounding and	Protective conductor terminal or protective grounding pin	<1> >25 A (50 or 60 Hz), or <2> 1.5 times the rated device current, whichever is greater.	0.1 Ω or less	5 to 10 sec • The no-load voltage must be 6 V or less.
IEC 60950 1997 Safety of Information Technology Equipment	No distinction	Between the following sections of class-I devices requiring grounding and <1> Accessible conducting parts <2> Protective shielding <3> Metal barriers	Protective grounding terminal or protective grounding pin	1.5 times the current capacity of circuits generating dangerous voltages. Note that this should be 25 A or less AC or DC.	0.1 Ω or less	Not specified • The test voltage must be 12 V or less. • In measurements of resistance, do not include the value for the AC power cord's protective grounding wire.
IEC 61010-1 1995 Safety Requirements for Electrical Equipment for Measurement, Control and Laboratory use - Part 1: General Requirements	Type test	Between the following sections of class-I devices requiring grounding and <1> Accessible conducting parts <2> Protective shielding <3> Metal barriers	Protective conductor terminal or protective grounding pin	<1> 25 A DC or 25 A AC (at the rated frequency of the power supply) <2> 2 times the rated device current, whichever is greater.	0.1 Ω or less	1 minute • In measurements of resistance, do not include the value for the AC power cord's protective grounding wire.
	Routine test	Between all accessible conducting parts of class-I devices requiring grounding and	Grounding pin for an AC inlet or power plug on the device side or protective grounding terminal of permanently installed equipment	Not specified	See Remarks.	1 minute • The voltage drop should not exceed 10 V DC or AC.
				See Remarks.	Not specified	• Continuity should be detected during earth continuity testing.

Standard	Type test/routine test	Main test points	Test current	Allowable resistance value	Test time	Remarks
UL1492 1993 Audio-Video Products and Accessories (UL1492 1993 will be withdrawn on Jan. 01, 2006, it will replace to UL6500-99)	Type test	Between accessible conducting parts of class-I devices requiring grounding and	Not specified	0.1 Ω or less	Not specified	<ul style="list-style-type: none"> If resistance exceeds 0.1 Ω, perform the test at 60 Hz, 20 A. The no-load voltage must be 12 V or less. Obtain a resistance value by the dividing voltage drop by the flowing current. In measurements of resistance, do not include the value for the AC power cord's protective grounding wire.
		The part of the device to which the grounding wire of the AC power cord is connected	60 Hz, 20 A	0.1 Ω or less	Not specified	
UL1950 1998 Safety of Information Processing Equipment	Routine test	Between all accessible conducting parts of class-I devices requiring grounding and	Not specified	See Remarks.	Not specified	<ul style="list-style-type: none"> Continuity should be detected during earth continuity testing using an ohmmeter, or a combination of battery and buzzer.
		Between the following sections of class-I devices requiring grounding and parts <1> Accessible conducting parts <2> Protective shielding <3> Metal barriers	1.5 times the current capacity of a circuit generating dangerous voltages. Note that this should be 25 A or less AC or DC.	0.1 Ω or less	Not specified	<ul style="list-style-type: none"> The test voltage must be 12 V or less. Calculate a resistance value from the flowing current and voltage drop. In measurements of resistance, do not include the value for the AC power cord's protective grounding wire. Exercise care so that the test results are not affected by the contact resistance between the end of a measuring probe and the metal part being tested.
UL2601-1 1997 Medical Electrical Equipment - Part 1: General Requirement for Safety	No distinction	Between accessible metal parts of class-I devices and	25 A (50 or 60 Hz) or current 1.5 times the rated device current	0.1 Ω or less	5 sec or more to 10 sec inclusive	<ul style="list-style-type: none"> The no-load voltage must be 6 V or less.
			Protective grounding terminal or (devices without AC power cords) Grounding pin for AC inlet on the device side (for equipment with removable AC power cords) Protective grounding pin for the power plug (for equipment with a fixed AC power cord)	0.2 Ω or less		

Standard	Type test/routine test	Main test points	Test current	Allowable resistance value	Test time	Remarks
UL3111-1 1994 Electrical Measuring and Test Equipment - Part 1: General Requirements	Type test	Between the following sections of class-I devices requiring grounding and parts <1> Accessible conducting parts <2> Protective shielding <3> Metal barriers	Protective conductor terminal or protective grounding pin <1> > 25 A DC or 25 A AC (at power supply's rated frequency) or <2> > 2 times the rated device current, whichever is greater.	0.1 Ω or less	1 minute	<ul style="list-style-type: none"> In measurements of resistance, do not include the value for the AC power cords protective grounding wire.
	Routine test	Between all accessible conducting parts of class-I devices requiring grounding and	For permanently installed equipment, a current twice that of the overcurrent prevention means specified by the installation manual	See Remarks.	1 minute	<ul style="list-style-type: none"> Voltage drop should not exceed 10 V DC or AC.
	Routine test	Between all accessible conducting parts of class-I devices requiring grounding and	Not specified	See Remarks.	Not specified	<ul style="list-style-type: none"> Continuity should be detected in earth continuity testing.
UL6500 1996 Standards for Safety for Audio/Video and Musical Instruments Apparatus for Household, Commercial, and Similar General Use. (UL6500 1996 will be withdrawn on 01. Jan. 2002, it will replace to UL6500-99)	Type test	Between a part to which connection must be made to produce an electric shock and	25 A AC or DC	0.1 Ω or less	1 minute	<ul style="list-style-type: none"> Test voltage must be 12 V or less. In measurements of resistance, do not include the value for the AC power cord's protective grounding wire. Exercise care so that the test results are not affected by the contact resistance between the end of a measuring probe and the metal part being tested.
	Routine test	Between accessible conducting parts presumed to lead to electric shocks if a grounding connection is absent and	Not specified	See Remarks.	Not specified	<ul style="list-style-type: none"> Continuity should be detected in earth continuity testing using an ohmmeter, or a combination of low-voltage battery and buzzer.
Electrical Appliance and Material Control Law of Japan	No distinction	Between all accessible conducting parts requiring grounding and	15 A	See Remarks. (0.1 Ω or equivalent, provided that the test current is 15 A)	Not specified	<ul style="list-style-type: none"> The test voltage must be 30 V or less. The measured voltage drop must be 1.5 V or less.

Standard	Type test/routine test	Main test points	Test current	Allowable resistance value	Test time	Remarks
JIS T 1001 1992 General Requirements for Safety of Medical Electrical Equipment JIS T 1002 1992 General Rules of Testing Methods for Safety of Medical Electrical Equipment	No distinction	Between all accessible conducting parts requiring grounding and	50 or 60 Hz, 10 A or greater to 25 A, inclusive	0.1 Ω or less	5 sec or more	<ul style="list-style-type: none"> Measure current and voltage by a voltage drop method to calculate a resistance value. For measurement conductors, use conductors with a sectional area of 3.5 mm² or greater; make them as short as possible. For connections between the measuring circuit, accessible metal parts, and protective grounding terminals, crimp or fix the connections to ensure adequately low contact resistance.
		Protective grounding terminal (for equipment without AC power cord)				
		Protective grounding pin for AC inlet on the device side (for equipment with removable AC power cord)				
JIS T 1022 1996 Safety Requirements of Electrical Installations for Medically Used Rooms in Hospitals and Clinics	/	Between a grounding pin, receiver of medical electrical outlet or terminal block of medical grounding terminals and	10 A to 25 A	0.1 Ω or less	Not specified	
		Between a conducting part provided with equivalent potential grounding and				

Type test : Test certifying conformity to the standard

Routine test : 100% test conducted in the production process

Class-I devices : Devices or equipment connecting parts with potentially dangerous voltages in the event of breakage of primary insulation to the protective grounding terminal of indoor wiring to prevent electric shock, in addition to primary insulation

NOTE

- The preceding table provides a summary of safety standards. Before performing actual testing, check the latest version of the applicable safety standard.

4. Initial Settings of the Memory

Memory number	Memory name	CURRENT	UPPER	LOWER	TIMER	FREQ	LOWER ON	OFFSET ON	TIMER ON
1	IEC60065(1)	25	0.1	0.001	60	50	0	0	1
2	IEC60065(2)	10	0.1	0.001	1	50	0	0	1
3	IEC60065(3)	10	0.2	0.001	1	50	0	0	1
4	IEC60204-1	10	0.1	0.001	10	50	0	0	1
5	IEC60335-1	25	0.1	0.001	1	50	0	0	1
6	IEC60601-1	25	0.1	0.001	5	50	0	0	1
7	IEC60950	25	0.1	0.001	1	50	0	0	1
8	IEC61010-1	25	0.1	0.001	60	50	0	0	1
9	UL1492	20	0.1	0.001	1	60	0	0	1
10	UL1950	25	0.1	0.001	1	60	0	0	1
11	UL2601-1(1)	25	0.1	0.001	5	60	0	0	1
12	UL2601-1(2)	25	0.2	0.001	5	60	0	0	1
13	UL3111-1	25	0.1	0.001	60	60	0	0	1
14	UL6500	25	0.1	0.001	60	60	0	0	1
15	EAMCL	15	0.1	0.001	1	50	0	0	1
16	JIS T 1001	25	0.1	0.001	5	50	0	0	1
17	JIS T 1002	25	0.1	0.001	5	50	0	0	1
18	JIS T 1022	25	0.1	0.001	1	50	0	0	1

NOTE

- The preceding initial set values for memory are examples of test conditions set under the following conditions, based on each safety standard.
 - Test current: The maximum value of the standardized range
 - Frequency: 60 Hz for UL standard or 50 Hz for other standards
 - Test duration: The minimum value of the standardized range (1 sec if not specified in the standard)

INDEX

GPIB Messages

*CLS	4-6
*ESR?	4-6
*IDN?	4-7
*RST	4-7
*SRE	4-8
*STB?	4-9
BUZZERVOL(BVOL)	4-15
CLR	4-9
COMMENT (COM)	4-16
CONTACTCHECK (CCH)	4-16
CONTRAST(CON)	4-17
CURRENT(CUR)	4-22
DOUBLEACTION(DAC)	4-18
DSE	4-10
DSR?	4-11, 4-31
ERR?	4-11, 4-12
FAIL?	4-12
FREQUENCY(FREQ)	4-23
IDATA?(IDAT?)	4-29
INVALID? (INV?)	4-12
LOWER (LOW)	4-24
MEASMODE (MMOD)	4-19
MEMORY (MEM)	4-33
MOMENTARY (MOM)	4-20
MON?	4-30
OFFSET (OFF)	4-26
PASSHOLD (PHOL)	4-21
PRGDEL (PDEL)	4-35
PRGEDIT (PED)	4-35
PRGINS(PIN)	4-36
PRGNAME(PNAM)	4-37
PRGNEW (PNEW)	4-38
PRGRETURN (PRET)	4-38
PRGTEST (PTES)	4-39
PRGTOTAL?(PTOT?)	4-39
PROTECTION? (PROT?)	4-12
RDATA? (RDAT?)	4-31
RECALL (REC)	4-34
SILENT (SIL)	4-13

START (STAR).....	4-27
STOP	4-28
STORE (STOR).....	4-34
TIME?.....	4-32
TIMER (TIM).....	4-27
TRM	4-14
UPPER (UPP).....	4-25
VDATA? (VDAT?).....	4-32

A

AC LINE	5-6
AC power cord	1-2, 1-5
Accessories	1-2
Acknowledgement message	4-4, 4-13
ASCII Codes 20H to 7EH	A-2
AUTO	2-22
AUTO / EDIT	5-4
AUX	5-7

B

Backup battery	6-3
Buzzer Volume	2-17, 4-15

C

Calibration	6-3
Cleaning	6-1
Clears of the registers	4-6
Comments	2-17, 4-16
Connecting to the DUT	1-12
Contact check	2-16, 4-16
Contrast	2-17
Cooling Fan	6-3
Cord holders	5-7
Creating or Editing the Program	2-23
Cursor	5-2

D	
Device Messages	4-6
Device status enable register	4-10, 4-42
Device status register	4-11, 4-30, 4-42
DISP 1	2-11
DISP 2	2-11
Double action	2-16, 4-18
E	
Ending the Test	2-11
Error register	4-11, 4-43
Event status register	4-6, 4-41
Example Programs	4-48
F	
Factory-shipped settings	2-30
FAIL judgment	2-12, 2-25
Fail mode	2-15, 4-18
Fail register	4-12, 4-43
Fan	5-7, 6-3
Feet	5-5
Frequency range	1-5
Front Panel	5-1
Function keys	5-2
Fuse	1-2, 6-2
G	
GPIB	4-1, 5-6, 7-7
GPIB Address	2-18
GPIB cable	4-1
GPIB interface	4-1
Grounding	1-6
H	
Handle	5-7
I	
In Case of Problems	6-4
Indicators	5-3
Initial Settings of the Memory	A-8
Initialize	2-30, 4-7
Inquires for the tester's test status	4-30
Inspection	6-1
Installation	1-3
Interface	2-18, 4-1
Interface communications rate	2-18
Interface Data Length	2-19
Interface Parity	2-19
Interval	2-24
Invalid setting register	4-12, 4-43
K	
Key Lock	2-26
L	
LCD	5-3
line voltage range	1-5
List of Device Messages	4-44
LOCAL/KEYLOCK	5-4
Lower Limit Judgment	2-6
Lower reference value	2-6, 4-24
LTP-2	P-6, 1-9
M	
MAIN/OFFSET	5-4
Measured current value	4-29
Measured resistance value	4-31
Measured voltage value	4-32
Measurement mode	2-14, 4-19
Measurements Using Four Terminals	1-10
Measurements Using Two Terminals	1-11
MEMORY	5-4
Memory contents	4-33
Messages	4-3
Mode	4-29
Momentary	2-15
Moving	1-4
N	
Nominal sectional areas	1-10
O	
Offset	2-9, 2-13
Offset cancel function	4-26
Offset measurement	2-13
Offset measurement screen	2-13
Operational Principle	A-1

Options	P-5	Response message terminator	4-5, 4-14
OUTPUT	5-2	RET	4-38
Output voltage limitation	2-29	ROM version	P-1, 4-7
OVER VOLT	2-4, 2-7, 4-22	Rotary knob	5-2
Overheating protection	2-27	RS-232C	4-1, 5-7
Overload protection	2-28	RS-232C flow control	4-2
P		RS-232C pin layout	4-2
Packing materials	1-1	Running the Program	2-25
Panel Memory	2-2, 2-20	S	
Panel Memory and Program	3-6	Safety standards	2-2
PASS hold	4-21	SAMPLING	5-3
PASS Hold Time	2-14	Service request enable register	4-8, 4-41
PASS judgment	2-11, 2-25	Set on the tester SYSTEM screen	4-15
Pause time	1-4	Setting Test Current	2-4
PM signal	3-6	Setting the Test Conditions	2-2
POWER	5-1	SHIFT	5-2
Precautions for installation	1-3	Shifts the LCD to each mode	4-29
Precautions for moving	1-4	SIGNAL I/O	5-6
Preliminary Inspection	1-13	SIGNAL I/O Connector	3-2
Program	2-22	SIGNAL I/O signal	2-29
Program message terminators	4-5	START	5-2
Program messages	4-3	Start momentary	4-20
Program name	2-23, 4-37	START signal	3-5
Program number	4-38	Starting a Test	2-10, 3-5
Program PASS/FAIL Judgment	2-25	Starts testing	4-27
Program screen	2-22	Status byte register	4-9, 4-41
Program step	4-35, 4-36, 4-39	STB signal	3-6
Protection	2-27	STOP	5-2
Protection register	4-12, 4-42	Stop Bit	2-19
R		Stops a test	4-28
RC01-TOS	P-5	Storing in the Panel Memory	2-20
RC02-TOS	P-5	Stors memory	4-34
Ready status	2-10	Summary of the Safety Standards	A-3
Rear Panel	5-6	Suspending the Program	2-25
Recalling the Panel Memory	2-21	SYSTEM	2-14
Recalling the Program	2-23	System Setup	2-14
Recalls memory contents	4-34	SYSTEM / I/F	5-4
Recalls program	4-39	T	
Registers	4-40	Terminator	4-5
REMOTE	3-1, 5-2	Test current	2-4, 4-22
Remote Control Box	P-5	Test current and time	2-27
Resistance measurement mode	4-19	Test frequency	2-5, 4-23

Test Lead	1-7
Test Probe	P-6, 1-9
Test time	2-9, 4-32
Time limitation with respect to output	7-2
Timer	2-8, 4-27
TL11-TOS	1-2, 1-7
Turning on the power	2-1

U

Unpacking	1-1
UP<=LOW	2-7, 4-25
Upper reference value	2-7, 4-25